

L'Architettura è il gioco sapiente,
rigoroso e magnifico, dei volumi
assemblati nella luce.

Architecture is the masterly, correct
and magnificent play of masses
brought together in light.

(Le Corbusier)

ROSSINI
LIGHT

INDICE INDEX

18  **NASHI** *evo*

32  **NISO**

38  **BILL** *evo*

44  **MÓN**

50  **CERCLE**

56  **KANT**

62  **DRACMA** *evo*

68  **OPTIKA**

74  **KINA** *evo*

78  **SMART**

82  **POINT**

88  **FIT**

UNA STORIA,
VOI ENOI.
A HISTORY, YOU AND US.



Da oltre 90 anni, abbiamo l'orgoglio di essere al vostro fianco, giorno dopo giorno, per donare magia e atmosfera ai vostri spazi.

La nostra passione per l'illuminazione si traduce in soluzioni su misura, in un connubio di design, tecnologia e creatività.

Traduciamo le vostre idee in realtà luminose per far brillare ogni ambiente con uno stile unico.

La nostra missione è condividere con voi la magia della luce, trasformando spazi in luoghi in cui poter vivere emozioni e creare ricordi.

For over 90 years, we are proud to be at your side, day by day, to give you magic and atmosphere to your spaces.

Our passion for lighting translates into tailor-made solutions, between design, technology and creativity.

We convert your ideas into bright realities to make every environment shine with a unique style.

Our mission is to share with you the magic of light, transforming spaces in places where you can live emotions and create memories.



SOSTENIBILITÀ.

**UN IMPEGNO,
UN MODO
DI PROGETTARE,
UNA SCELTA.**

SUSTAINABILITY.

COMMITMENT,
A WAY
OF DESIGN,
ONE CHOISE.

PROJECT

Sappiamo quanto sia importante avere un'illuminazione efficace e di qualità in ambienti lavorativi e didattici, poiché questa influisce direttamente sulla produttività, sulla concentrazione ed il benessere degli individui. Ecco perché ci siamo dedicati allo sviluppo di prodotti che forniscano una soluzione illuminotecnica corretta per questi spazi.

In questa brochure troverete una selezione di prodotti altamente performanti che ben si integrano nei diversi contesti di questi ambienti.

La nostra gamma include lampade a LED progettate con differenti indici UGR, adeguati ai vari ambiti di applicazione, oltre ad apparecchi che offrono una luce uniforme e senza sfarfallio eliminando l'affaticamento degli occhi e garantendo una vista chiara e confortevole.

Oltre alle alte prestazioni, la nostra attenzione al design, la possibilità di richiedere finiture personalizzate, l'integrazione di sensori di presenza o di luminosità, la dimmerazione degli apparecchi, ci hanno portato a creare soluzioni che si integrano perfettamente negli ambienti lavorativi, nelle scuole e in altri ambienti pubblici o privati.

L'esperienza pluriennale nel settore illuminotecnico ci consente di offrire prodotti affidabili e altamente performanti per dotare gli spazi di una luce di qualità.

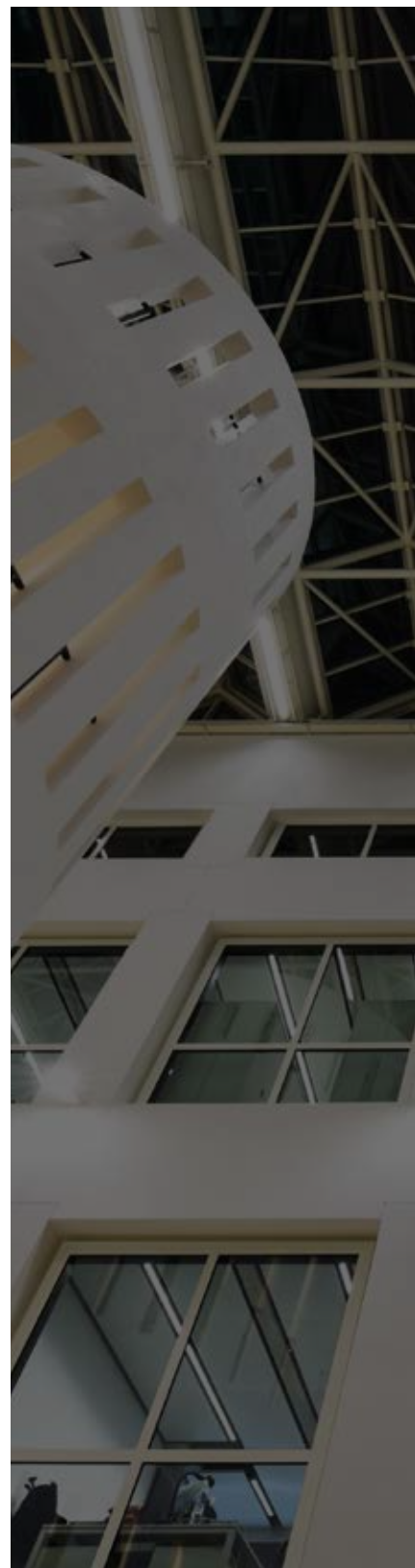



We know how important it is to have effective, high-quality lighting in workplaces and educational settings, as it has a direct influence on productivity, concentration and individual wellbeing. That is why we are committed to developing products which provide the right lighting solution for these spaces.

In this brochure you will find a selection of high-performance products that fit well into the diverse contexts of these environments.

Our range includes LED lighting designed with different UGR degrees, suitable for various areas of application, as well as luminaires that provide uniform, flicker-free light preventing eye strain and ensuring clear and comfortable vision.

Our focus on aesthetic design, high performance, the ability to request custom finishes, the integration of occupancy or light sensor and the dimming of luminaires, have led us to create solutions that integrate seamlessly with work spaces, schools and other public or private environments.

Our extensive experience in the lighting design sector allows us to offer reliable and high performance products that provide spaces with quality light.

COMPETENZE

“
“ **Creare prodotti
che migliorino l’ambiente
in cui sono installati,
offrendo una luce di qualità
che contribuisca a ottimizzare
il comfort visivo e che
abbia un forte impatto
sul benessere delle persone.** ”
”

Rossini illuminazione vi offre una vasta gamma di prodotti illuminotecnici per differenti ambiti applicativi, adatti sia al settore pubblico che privato, che rispondono ad esigenze progettuali nel comparto commerciale, nel retail, negli spazi horeca, in scuole, uffici e nel mondo residenziale, garantendo un elevato standard di qualità ed un servizio "custom made" che possa soddisfare appieno le esigenze progettuali.

La personalizzazione è un elemento chiave, poiché ogni progetto è unico e richiede una soluzione illuminotecnica su misura.

Grazie alla nostra competenza ed all'esperienza acquisita, sia che siate alla ricerca di una caratterizzazione minima o di una soluzione completamente "su misura", il nostro team di esperti è pronto ad accogliere le vostre richieste ed a sviluppare insieme a voi soluzioni illuminotecniche che si adattano perfettamente al vostro concept creando l'ambiente desiderato.

EXPERTISE

“ We create products which improve the space where they are installed, offering high quality light that helps to optimise visual comfort and has a strong impact on people’s wellbeing. ”

Rossini illuminazione offers a wide range of lighting products for different fields of application, suitable for both the public and private sector, meeting design needs in the commercial sector, retail, horeca, schools, offices, and the residential world, guaranteeing a high standard of quality and also to offer a bespoke customisation service which fully satisfies the needs of our clients.

Customisation is key, as each project is unique and requires a tailor-made lighting solution.

By drawing on our extensive and experience in the field of lighting, whether you are looking for minor customisation or a fully bespoke solution, our team of experts is ready to accommodate your requests and to develop with you the space you desire, bringing your ideas to life and offering lighting solutions that exceed your expectations.

SOLUZIONI TECNOLOGIA PRESTAZIONI BENESSERE

Alla ricerca del perfetto equilibrio tra progettualità e benessere

La nostra selezione di prodotti dedicata alla progettazione è il connubio tra l'eccellenza della tradizione progettuale unita all'avanguardia della tecnologia e alle tendenze di design.

Il nostro scopo è quello di offrire un'illuminazione che non solo soddisfi le esigenze funzionali, ma anche porti benessere alle persone che vivono l'ambiente, attraverso una fonte luminosa progettata per ogni situazione.

Tecnologia all'avanguardia per performance senza compromessi

Ci dedichiamo continuamente a sperimentare nuove tecnologie. Ogni prodotto nel nostro catalogo è frutto di un processo di sviluppo attento e meticoloso, mirato a garantire alte prestazioni e consumi ridotti. Dai sistemi LED ad alta efficienza energetica alle soluzioni smart, tutte le nostre proposte sono progettate per superare gli standard di qualità più elevati.

L'attento controllo delle prestazioni

La nostra attenzione alla qualità e alle prestazioni si riflette nella fase di controllo dei prodotti. Ogni elemento è sottoposto a rigorosi test per garantire alti livelli di affidabilità e funzionalità.

Siamo orgogliosi di fornire prodotti che mantengano la loro performance nel tempo e che rispondano alle richieste più esigenti in termini di durata e resa luminosa.

Soluzioni su misura per ogni ambiente

Ogni ambiente ha esigenze diverse e uniche in termini di illuminazione. Il nostro team è pronto ad assistervi nella scelta della soluzione ideale per il vostro progetto o creare soluzioni personalizzate.

Sia che siate alla ricerca di un'illuminazione sofisticata per spazi commerciali, confortevole per scuole ed uffici o accogliente per ambienti residenziali, offriamo una vasta gamma di prodotti e servizi personalizzati per rispondere a ogni vostra esigenza.

SOLUTIONS TECHNOLOGY PERFORMANCE WELL-BEING

Looking for a perfect balance between project and well-being

Our selection of design-focused products blends the best of design tradition with cutting-edge technology and design trends.

Our aim is to offer lighting that not only meets functional needs, but also bring well-being to the people in the environment, through a light source designed for every situation.

High level of technology for exceptional performance

We maintain a constant focus on experimenting with new technology. Each product in our catalogue is the result of a careful and meticulous process of development, aimed at guaranteeing exceptional performance. From energy-efficient LED systems to smart solutions, all our products are designed to exceed the highest quality standards.

A detailed check of performance

Our focus on quality and performance is reflected in our product quality control phase. Each item undergoes rigorous testing to ensure high levels of reliability and functionality.

We are proud to provide products that deliver long-lasting performance and that meet the most stringent demands in terms of lifespan and light output.

Bespoke solutions for every setting

We understand that each setting has its own unique lighting requirements. Our team is here to guide you in choosing the perfect solution for your project. Whether you are looking for sophisticated lighting for commercial spaces, comfortable for school and office or cosy light for residential settings, we offer a wide range of custom products and services to meet your every need.

UFFICIO

Dove il lavoro incontra il benessere.

L'illuminazione degli ambienti di lavoro è da sempre un tema che lega sicurezza, efficienza e benessere.

Il rispetto della normativa sull'illuminazione negli ambienti di lavoro prevede dei parametri stringenti declinati in base al tipo di attività svolta: controllo dell'abbagliamento, adeguata illuminazione del piano di lavoro, corretto rapporto luce/ombra e giusto mix di luce naturale/artificiale.

Negli ultimi decenni si sono aggiunti altri parametri tecnici importanti come l'indice di resa cromatica, il mantenimento del flusso, il consumo, la manutenzione, il flicker, etc.

Oggi, è un dato acquisito che la luce è molto di più: incidenza sul benessere, sulla creatività e produttività; capacità di interfacciarsi con sistemi domotici; interazione tramite sensori; armonizzazione estetica con l'ambiente circostante e, spesso, questa esprime anche l'identità corporate.

La normativa CAM (criteri ambientali minimi) ha voluto sottolineare l'importanza e la centralità di tutti questi fattori chiamando il progettista ad osservare alcuni parametri fondamentali nella scelta dei prodotti. Per questo motivo Rossini illuminazione ha selezionato e sviluppato dei prodotti ad hoc a supporto del progettista.

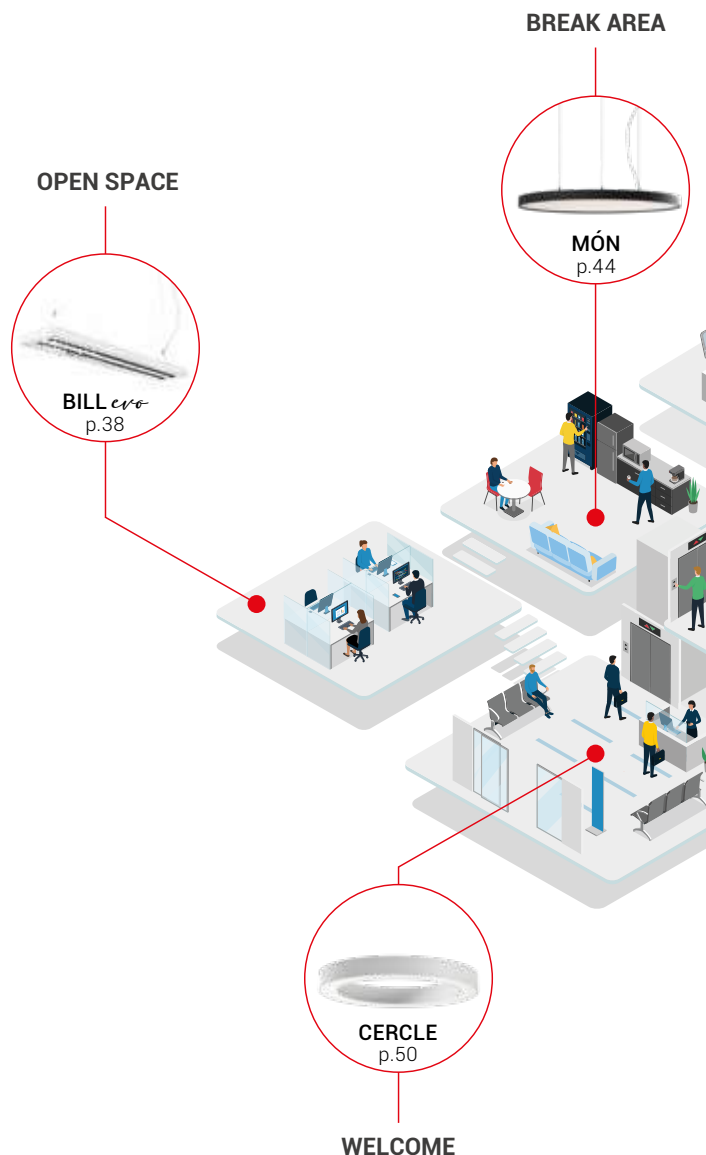

SPAZIO OPEN SPACE

La luce gioca un ruolo cruciale in questo spazio, nato per supportare attività di concentrazione e con l'obiettivo di favorire anche la collaborazione, condivisione, scambio di idee, favorendo una maggiore creatività utile al raggiungimento di obiettivi aziendali sempre più sfidanti, e dona alto benessere ai dipendenti. Un ambiente con luce diffusa e puntuale aumenta la produttività e influenza positivamente le persone.

SPAZIO INDIVIDUALE

L'illuminazione nelle aree individuali è fondamentale per creare una zona di lavoro confortevole ed efficiente. Una corretta disposizione delle luci sul piano di lavoro, combinata con una buona illuminazione negli angoli bui dell'ufficio, elimina le ombre fastidiose e offre una visione chiara delle attività svolte.

SPAZI DI SOCIALIZZAZIONE - AREA BREAK E CAFFÈ

Questi ambienti necessitano di una illuminazione che possa creare una sensazione di calma e relax per trascorrere una pausa rigenerante, favorire la creatività nei momenti di brainstorming e offrire la giusta atmosfera per confronti spontanei con i colleghi o incontri pianificati con clienti e fornitori.

SPAZI DI COLLABORAZIONE

Negli spazi dedicati alla collaborazione l'illuminazione gioca un ruolo fondamentale nel garantire incontri produttivi ed efficaci. Una luce adeguata favorisce la partecipazione attiva e l'interazione tra i partecipanti. L'illuminazione ben studiata deve inoltre evitare riflessi fastidiosi sulle superfici, per assicurare una vista chiara e confortevole a tutti i partecipanti.

OFFICE

Where work meets well-being.

Lighting work spaces has always been a topic that links safety, efficiency and well-being.

Compliance with lighting regulations in work spaces involves strict parameters that vary according to the type of activity being carried out: glare control, adequate lighting of the work surface, the correct ratio of light and shadow and the right mix of natural and artificial light.

In recent decades these have been joined by other important technical parameters such as colour rendering index, lumen maintenance, consumption, maintenance, flicker, and so on.

Today, it is an established fact that light offers far more: influence on wellbeing, creativity and productivity; the ability to interact with smart systems; interaction through sensors; aesthetic harmony with the surrounding environment; and often it also expresses corporate identity.

CAM (Minimum Environmental Criteria) regulations aim to highlight the importance and central role of all these factors, requiring the designer to respect certain key parameters in their choice of product. Rossini Illuminazione therefore selects and develops ad hoc products thus supporting designers.

INDIVIDUAL SPACE



NASHI *eye*
p.18

OPEN SPACE



OPTIKA
p.68



NISO
p.32

MEETING ROOM

OPEN SPACE

Light plays a crucial role in this kind of space, created to support focused activities and intended to foster collaboration, sharing, and the exchange of ideas, promoting greater creativity to help achieve increasingly challenging corporate goals, as well as providing a high level of wellbeing to employees. A diffuse and punctual light environment space increases productivity and has a positive effect on people.

INDIVIDUAL SPACE

Lighting in individual spaces is fundamental for creating a comfortable and efficient work area. The proper arrangement of lights on the work surface, combined with good lighting in any dark spots in the office, eliminates unwanted shadow and offers a clear view of activities.

SOCIAL SPACES – BREAK AND COFFEE AREAS

These spaces need lighting that will create a feeling of calm and relaxation for a restorative break, foster creativity during brainstorming sessions, and offer the right atmosphere for spontaneous discussions with colleagues or planned meetings with clients and suppliers.

COLLABORATIVE SPACES

Lighting in collaborative spaces plays a fundamental role in ensuring productive and effective meetings. Proper lighting not only creates a welcoming atmosphere, but also encourages active participation and interaction between participants. Well-designed lighting should also prevent unwanted surface reflections, to ensure clear and comfortable view to all participants.

SCUOLA

Illuminare la conoscenza

L'illuminazione gioca un ruolo cruciale nel contesto didattico, poiché influisce profondamente sullo sviluppo e sul benessere degli studenti. Nei vari locali scolastici, una corretta illuminazione crea un ambiente propizio all'apprendimento, alla concentrazione e alla creatività.

Gli ambienti educativi, dal punto di vista dell'illuminazione, hanno molte esigenze in comune a quelli lavorativi. Anche in questo caso, la normativa prevede parametri stringenti in base all'attività da svolgere.

L'uso di computer e tablet, LIM, sale lettura, aree meeting, corridoi, ogni ambiente ha il suo "compito visivo" e quindi una necessità da soddisfare. A questo si aggiungono fattori come risparmio energetico, bassa manutenzione, comandi centralizzati, adattabilità all'ambiente, ma anche sicurezza e benessere.

La normativa CAM è intervenuta regolando i principi di scelta cui il progettista deve fare riferimento, anche in questo caso Rossini Illuminazione è di supporto a chi deve operare queste scelte fornendo un'ampia gamma di soluzioni che rispettano la normativa.

Uno studio accurato ha permesso di creare una gamma che soddisfi le più svariate esigenze degli spazi scolastici, con la massima attenzione al benessere degli alunni, degli insegnanti e di tutto il personale che quotidianamente vivono quegli spazi.

SPACE FOR STUDY AND RESEARCH

CLASSROOM

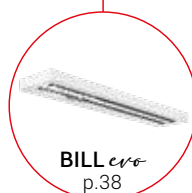

OPTIKA

p.68



LAB

AULE

Sorgenti luminose LED di alta qualità, con opzioni di regolazione dell'intensità e del colore, sono ideali per adattare l'illuminazione alle diverse attività didattiche. Un'illuminazione uniforme e diffusa evita riflessi fastidiosi sulle lavagne o sui dispositivi elettronici, offrendo una vista chiara per tutti gli studenti.

SPAZI PER LO STUDIO E LA RICERCA

Qui la luce svolge un ruolo cruciale per favorire lo studio e la ricerca. Un'illuminazione uniforme e ben distribuita su tavoli e ripiani consente agli studenti di leggere e studiare senza affaticamento visivo.

LABORATORI

Nei laboratori scientifici e artistici l'illuminazione focalizzata e direzionale consente di concentrarsi su dettagli e procedure, mentre un'illuminazione diffusa favorisce un ambiente sicuro e confortevole. Nei laboratori di arte o fotografia la luce può essere modulata per esaltare i colori e gli aspetti estetici delle opere.

AREE COMUNI

Nelle aree comuni, come la sala mensa o gli spazi di incontro, la luce deve creare un'atmosfera accogliente e favorire la socializzazione. L'illuminazione morbida e calda contribuisce a creare un ambiente rilassante, promuovendo momenti di convivialità tra gli studenti. Illuminazione gradevole e diffusa invece negli ingressi, corridoi o scale per ricreare un'atmosfera piacevole.

SCHOOL

Shedding light on knowledge

Lighting plays a crucial role in educational settings, as it has a profound influence on student development and wellbeing. Throughout the school premises, proper lighting can create an environment conducive to learning, concentration and creativity.

In terms of lighting, educational settings have many requirements in common with work spaces. Regulations for these settings also involve strict parameters based on the activities being carried out.

The use of computers and tablets, interactive whiteboards, reading rooms, meeting areas, corridors: every space has its own "visual task", and therefore a specific need to be met. This is in addition to factors such as energy saving, low maintenance, centralised controls, suitability for the setting, as well as safety and wellbeing.

CAM regulations are in place to govern the criteria designers must follow, and Rossini Illuminazione once again offers support to those making these decisions, providing a wide range of solutions that comply with regulations.

Careful product research has allowed us to create a range that meets the various requirements of school spaces, with a strong focus on the wellbeing of the students, teachers and all the staff who use those spaces.

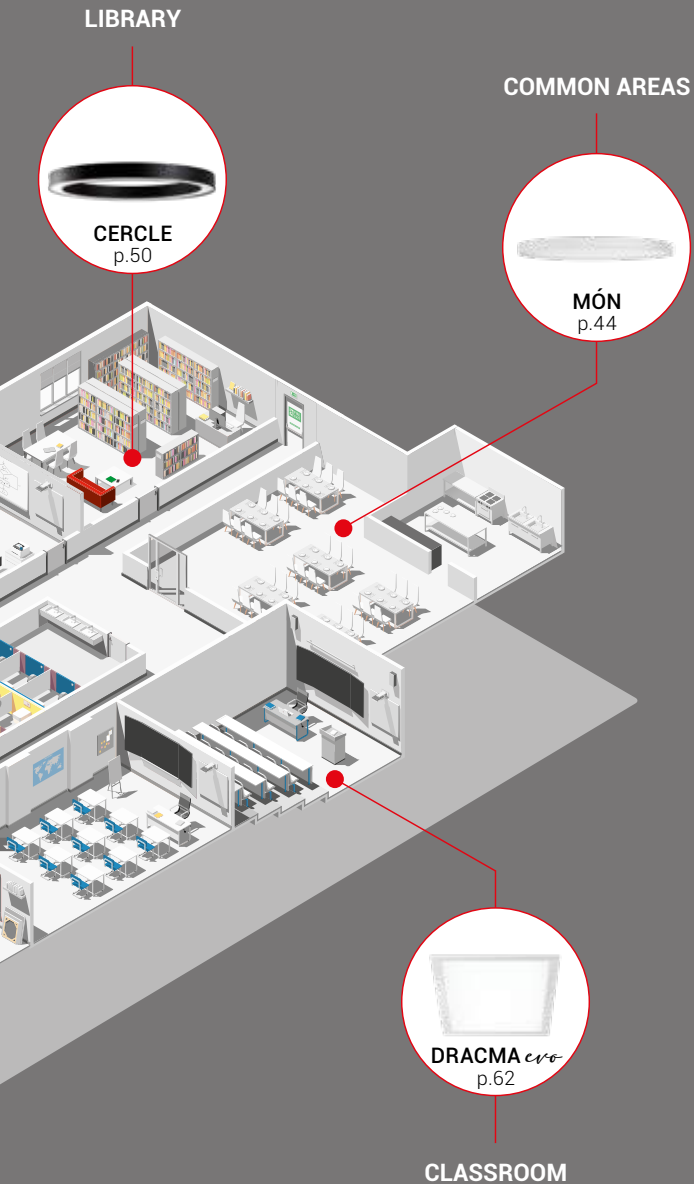

CLASSROOMS

High quality LED light sources, with options to adjust brightness and colour, are ideal for adapting lighting to different educational activities. Uniform, diffuse lighting prevents unwanted reflections on whiteboards or electronic devices, offering all students a clear view.

SPACE FOR STUDY AND RESEARCH

Here light plays a crucial role in encouraging study and research. Uniform lighting that is well distributed over tables and surfaces allows students to read and study without straining their eyes.

LABS

In science and art labs, focused and directional lighting makes it possible to concentrate on details and procedures, while diffuse lighting provides a safe, comfortable environment. In art or photography laboratory, light can be adjusted to enhance the colours and aesthetic features of the work.

COMMON AREAS

In common areas such as dining hall or meeting spaces, light should create a welcoming atmosphere and encourage social activity. Soft, warm lighting helps to create a relaxing environment, promoting social interaction between students. Pleasant, diffuse lighting in entrance halls, corridors or on stairs creates a pleasing atmosphere.

CAM CRITERI AMBIENTALI MINIMI

"Piano d'Azione Nazionale sul Green Public Procurement (PANGPP)"

I requisiti sono sviluppati secondo quanto articolato dal DM 23 giugno 2022 n.256 "Affidamento di servizi di progettazione e affidamento di lavori per interventi edilizi", pubblicato su GURI n. 183 del 8 agosto 2022. Fermo restando quanto previsto dal DM 26 giugno 2015 "Applicazione delle metodologie di calcolo delle prestazioni energetiche e definizione delle prescrizioni e dei requisiti minimi degli edifici".

In sintesi, i CAM sono i requisiti per le varie fasi del processo di acquisto del settore della pubblica amministrazione. La loro applicazione sistematica consente di diffondere tecnologie e prodotti compatibili con l'ambiente, producendo un effetto leva sul mercato.

Nei diversi settori coinvolti da questa iniziativa, quello dell'illuminazione rientra nell'ambito del "capitolo" Edilizia.

Come definito dagli artt. 2.4.3 e 4.3.6, i CAM si applicano ad interventi sia di nuova costruzione che ricostruzione e degli interventi di ristrutturazione, sottolineando che gli impianti d'illuminazione devono essere conformi alla norma UNI EN 12464-1, ed avere le seguenti caratteristiche:

- Efficienza energetica uguale o superiore a 80 lm/W.
- Resa cromatica uguale o superiore a 90 per ambienti interni.
- Resa cromatica uguale o superiore a 80 per ambienti esterni.
- Dotati di sistemi di gestione e automazione: accensione, spegnimento e dimmerizzazione. In particolare, la dimmerizzazione deve essere fatta su base rilevazione dello stato di occupazione delle aree, livello di illuminamento medio esistente e fascia oraria. Questo requisito deve essere garantito per edifici ad uso non residenziale e per edifici ad uso residenziale limitatamente alle aree comuni.
- Le lampade a LED per utilizzi in abitazioni, scuole ed uffici devono avere una durata minima di 50.000 ore.

MINIMUM ENVIRONMENTAL CRITERIA

"National Action Plan on Green Public Procurement (PANGPP)"

The requirements are developed according to the Ministerial Decree of 23 June 2022 n.256 "Entrustment of planning services and entrustment of works for building works", published in GURI n. 183 of 8 August 2022 and according to the Ministerial Decree of 26 June 2015 "Application of the methodologies for calculating energy performance and defining the minimum requirements of buildings".

In summary, MEC are the requirements for the various stages of the purchase process of the public administration sector. Their systematic application makes it possible to disseminate environmentally friendly technologies and products, which has a leverage effect on the market.

In the different sectors involved in this initiative, the lighting sector is part of the Building chapter.

As defined by art. 2.4.3 and 4.3.6, the MEC are applied for new construction, reconstruction and renovation, which the lighting systems must comply with the UNI EN 12464-1 standard, and they must have the following characteristics:

- Energy efficiency equal to or greater than 80 lm/W.
- Colour rendering of 90 or more for indoor use.
- Colour rendering of 80 or more for outdoor use.
- Equipped with management and automation systems: on, off and dimming. Dimming should be done based on the occupancy status of areas, existing average illuminance level and time slot. This requirement must be guaranteed for non-residential buildings and residential buildings limitedly to common areas.
- LED lamps used in homes, schools and offices must have a minimum lifetime of 50,000 hours.





NASHI *evo*

DESIGN QUALIFICATO SKILLED DESIGN

Sistema lineare versatile e modulare che permette di realizzare composizioni adeguate alle differenti esigenze progettuali. Corpo realizzato interamente in alluminio estruso "Made in Italy" progettato per installazione a sospensione o a soffitto. Ottiche e diffusori in policarbonato con moduli LED di ultimissima generazione ad elevata efficienza e un'emissione luminosa controllata. Il nuovo Nashi Evo, esternamente, conserva le sue caratteristiche estetiche che lo contraddistinguono.

Versatile and modular linear luminaire to create compositions for different design needs. "Made in Italy" extruded aluminium body for suspension or ceiling installation. Polycarbonate optics and diffusers with high efficiency latest generation LED modules and controlled light emission. New Nashi Evo, externally, retains its distinctive aesthetic features.



Configurazioni in linea o ad angolo, con differenti soluzioni di installazione e di fasci luminosi. Ideale per la progettazione di svariati ambienti grazie alla sua applicabilità a numerosi ambiti di lavoro, horeca, retail, aree comuni, nonché residenziali.

In-line or angle configuration with different installation solutions and light beams. It's ideal for designing varied environments thanks to its applicability numerous areas of work, horeca, retail, public, as well as residential areas.



Schermo microprismato Microprismatic diffuser



Ottica con lenti UGR <19 Optic with lens UGR <19

NASHI *evo* CUSTOM PROJECT



LINEA PASSANTE SU PROGETTO
ACCENSIONE SEPARATA PARTE DIRETTA E INDIRETTA
ACCENSIONE ALTERNATA DEI CORPI ILLUMINANTI
COLORE/FINITURA SU SPECIFICA DEL CLIENTE
SISTEMI DI GIUNZIONE DEI PROFILI: T e X
FLUSSO LUMINOSO E CCT DIVERSI DA QUELLI STANDARD
EMERGENZA INTEGRATA NEL CORPO LAMPADA
LUNGHEZZE SU MISURA
SISTEMI DI DIMMING SPECIFICI
GRUPPI OTTICI SPECIFICI: ASIMMETRICO, NARROW

OUTSIDE LINE ON A PROJECT
SEPARATE DIRECT AND INDIRECT IGNITION
ALTERNATING IGNITION OF LUMINAIRES
COLOUR/FINISH TO CUSTOMER SPECIFICATION
JOINING PROFILE SYSTEMS: T and X
LUMINOUS FLUX AND CCT OTHER THAN STANDARD
EMERGENCY INTEGRATED IN THE LAMP BODY
CUSTOMIZED LENGTHS
SPECIFIC DIMMING SYSTEMS
SPECIFIC OPTICAL UNITS: ASYMMETRIC, NARROW



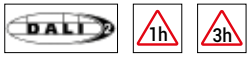
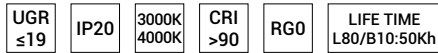
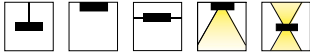

Sistema di dimming che permette di utilizzare indifferentemente un segnale DALI o il Push DIM. Il riconoscimento verrà effettuato in automatico dal dispositivo.

Dimming system that allows the use of a DALI signal or the Push DIM. The recognition will be done automatically by the device.

FINITURE FINISHES

Bianco e nero. Verniciatura a polvere.
White and black. Powder coating.



Bianco White



Nero Black

EMISSIONE LUMINOSA LIGHT EMISSION

Monoemissione a luce diretta e biemissione a luce diretta-indiretta. Disponibile anche nella versione con controllo dell'UGR (<19). Su richiesta è possibile realizzare emissioni particolari: simmetriche con angolo stretto, asimmetriche, etc.

Luminaire for direct and direct/indirect light emission. Available in the UGR controlled version (<19). On request it's possible to realize particular light emission: symmetric with narrow angle, asymmetric, etc.



NORMATIVE REGULATIONS

EN 60598-1 (Apparecchi di illuminazione, prescrizioni generali)
EN 62471 (Rischio fotobiologico)
EN 12464-1 (Illuminazione dei luoghi di lavoro)
2014/35/UE (Direttiva bassa tensione)
2014/30/UE (Direttiva compatibilità elettromagnetica).

EN 60598-1 (Electric safety standards)
EN 62471 (Photobiological safety standards)
EN 12464-1 (Lighting of indoor workplaces)
2014/35/UE (Low Voltage Directive)
2014/30/UE (Electro-magnetic compatibility standards)

SORGENTE SOURCE

Moduli LED di ultimissima generazione, ad elevata efficienza. Disponibile in due temperature colori (3000K e 4000K), con CRI>90. Vita attesa 50.000 ore.

High efficiency latest generation LED modules, available in two gradation CCT 3000K and 4000K, CRI>90. Lifetime of 50.000 hours.

ELETRIFICAZIONE POWER SUPPLY

220-240Vac. Gruppo di alimentazione integrato, montato a bordo dell'apparecchio. Linea passante 3x1,5 e 5x1,5 (DALI). Su richiesta è possibile realizzare linee passanti a progetto a 3 fasi.

220-240V. On board driver. Outside line 3x1.5 and 5x1.5 (DALI). On request it's possible to create 3 phases outside lines.

CONTROLLO POWER SUPPLY

Nella versione standard DALI è possibile controllare in modo puntuale gli apparecchi grazie al protocollo DALI2 (compatibile anche con la precedente DALI).

In the standard DALI version, the device can be precisely controlled using DALI2 protocol (also compatible with previous DALI version).

APPLICAZIONI ENVIRONMENTS

Grazie all'ampia versatilità (luce diffusa, mono-bidirezionale, controllo dell'UGR) è ideale per installazioni nei centri direzionali, uffici e retail.

Thanks to its great versatility (diffused light, directional and bidirectional, UGR control it's ideal for installation in business hubs, offices and retail environment.

SU RICHIESTA UPON REQUEST

Finiture speciali. Doppia accensione. Ottiche, misure e flussi luminosi, versioni con linee passanti speciali, sensori di presenza, luminosità ed emergenza 1h/3h.

È possibile customizzare/realizzare prodotti e/o accessori ad hoc.

Special finishes. Double ignition. Optics, sizes and luminous fluxes, versions with special outside lines, motion, twilight and emergency sensor with 1/3 hours battery life.

it's possible to customize/create specific products and/or accessories.

MONOEMISSIONE MONTAGGIO SINGOLO DIRECT LIGHT SINGLE MOUNTING

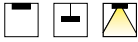

Codice Code	Potenza Power	Flusso effettivo Real flux	Efficienza Efficiency	CCT	Dimensioni mm Dimensions mm	Peso Weight
OTTICA OPTIC UGR 19						
NAE303XX	25W	3130 lm	127 lm/W	3000K	1150 x 65 x 75	2,5 kg
NAE304XX	25W	3254 lm	132 lm/W	4000K	1150 x 65 x 75	2,5 kg
NAE307XX	37W	4694 lm	127 lm/W	3000K	1690 x 65 x 75	2,5 kg
NAE308XX	37W	4882 lm	132 lm/W	4000K	1690 x 65 x 75	2,5 kg
DIFFUSORE MICROPRISMATO MICROPRISMATIC DIFFUSER						
NAE301XX	22W	2412 lm	111 lm/W	3000K	1150 x 65 x 75	2,5 kg
NAE302XX	22W	2682 lm	123 lm/W	4000K	1150 x 65 x 75	2,5 kg
NAE305XX	33W	3618 lm	111 lm/W	3000K	1690 x 65 x 75	2,5 kg
NAE306XX	33W	4023 lm	123 lm/W	4000K	1690 x 65 x 75	2,5 kg

versione DALI 2 per tutti i codici
DALI 2 version available for all codes
esempio/example cod. **NAE303XXDA**

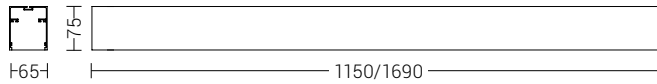

Finiture Finishing



B - bianco white



N - nero black

ottica UGR19
UGR 19 optic

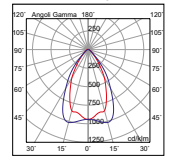

diffusore microprismato
microprismatic diffuser

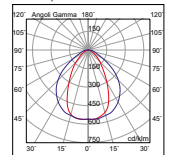

BIEMISSIONE MONTAGGIO SINGOLO DIRECT-INDIRECT LIGHT SINGLE MOUNTING



Codice Code	Potenza Power	Flusso effettivo Real flux	Efficienza Efficiency	CCT	Dimensioni mm Dimensions mm	Peso Weight
OTTICA OPTIC UGR 19						
NAE403XX	25W+8W	3130+1305 lm	137 lm/W	3000K	1150 x 65 x 75	2,5 kg
NAE404XX	25W+8W	3254+1395 lm	143 lm/W	4000K	1150 x 65 x 75	2,5 kg
NAE407XX	37W+16W	4694+2610 lm	139 lm/W	3000K	1690 x 65 x 75	2,5 kg
NAE408XX	37W+16W	4882+2790 lm	146 lm/W	4000K	1690 x 65 x 75	2,5 kg
DIFFUSORE MICROPRISMATO MICROPRISMATIC DIFFUSER						
NAE401XX	22W+8W	2412+1305 lm	126 lm/W	3000K	1150 x 65 x 75	2,5 kg
NAE402XX	22W+8W	2682+1395 lm	138 lm/W	4000K	1150 x 65 x 75	2,5 kg
NAE405XX	33W+16W	3618+2610 lm	129 lm/W	3000K	1690 x 65 x 75	2,5 kg
NAE406XX	33W+16W	4023+2790 lm	141 lm/W	4000K	1690 x 65 x 75	2,5 kg

versione DALI 2 per tutti i codici
DALI 2 version available for all codes
esempio/example cod. **NAE403XXDA**

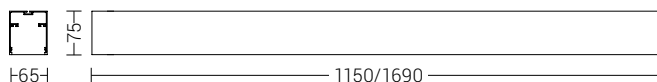

Finiture Finishing



B - bianco white



N - nero black

ottica UGR19
UGR 19 optic

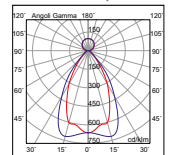

diffusore microprismato
microprismatic diffuser

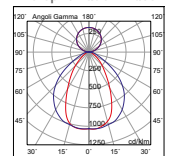



MONOEMISSIONE MONTAGGIO IN LINEA DIRECT LIGHT IN-LINE MOUNTING SYSTEM



Finiture Finishing



B - bianco white



N - nero black

Codice Code	Potenza Power	Flusso effettivo Real flux	Efficienza Efficiency	CCT	Dimensioni mm Dimensions mm	Peso Weight
----------------	------------------	-------------------------------	--------------------------	-----	--------------------------------	----------------

OTTICA OPTIC UGR 19 

Inizio linea / start line

NAE003XX	25W	3130 lm	127 lm/W	3000K	1150 x 65 x 75	2,5 kg
NAE004XX	25W	3254 lm	132 lm/W	4000K	1150 x 65 x 75	2,5 kg
NAE007XX	37W	4694 lm	127 lm/W	3000K	1690 x 65 x 75	2,5 kg
NAE008XX	37W	4882 lm	132 lm/W	4000K	1690 x 65 x 75	2,5 kg

intermedio / intermediate

NAE019XX	25W	3130 lm	127 lm/W	3000K	1130 x 65 x 75	2,5 kg
NAE020XX	25W	3254 lm	132 lm/W	4000K	1130 x 65 x 75	2,5 kg
NAE023XX	37W	4694 lm	127 lm/W	3000K	1670 x 65 x 75	2,5 kg
NAE024XX	37W	4882 lm	132 lm/W	4000K	1670 x 65 x 75	2,5 kg

fine linea / end line

NAE011XX	25W	3130 lm	127 lm/W	3000K	1150 x 65 x 75	2,5 kg
NAE012XX	25W	3254 lm	132 lm/W	4000K	1150 x 65 x 75	2,5 kg
NAE015XX	37W	4694 lm	127 lm/W	3000K	1690 x 65 x 75	2,5 kg
NAE016XX	37W	4882 lm	132 lm/W	4000K	1690 x 65 x 75	2,5 kg

DIFFUSORE MICROPRISMATO MICROPRISMATIC DIFFUSER

Inizio linea / start line

NAE001XX	22W	2412 lm	111 lm/W	3000K	1150 x 65 x 75	2,5 kg
NAE002XX	22W	2682 lm	123 lm/W	4000K	1150 x 65 x 75	2,5 kg
NAE005XX	33W	3618 lm	111 lm/W	3000K	1690 x 65 x 75	2,5 kg
NAE006XX	33W	4023 lm	123 lm/W	4000K	1690 x 65 x 75	2,5 kg

intermedio / intermediate

NAE017XX	22W	2412 lm	111 lm/W	3000K	1130 x 65 x 75	2,5 kg
NAE018XX	22W	2682 lm	123 lm/W	4000K	1130 x 65 x 75	2,5 kg
NAE021XX	33W	3618 lm	111 lm/W	3000K	1670 x 65 x 75	2,5 kg
NAE022XX	33W	4023 lm	123 lm/W	4000K	1670 x 65 x 75	2,5 kg

fine linea / end line

NAE009XX	22W	2412 lm	111 lm/W	3000K	1150 x 65 x 75	2,5 kg
NAE010XX	22W	2682 lm	123 lm/W	4000K	1150 x 65 x 75	2,5 kg
NAE013XX	33W	3618 lm	111 lm/W	3000K	1690 x 65 x 75	2,5 kg
NAE014XX	33W	4023 lm	123 lm/W	4000K	1690 x 65 x 75	2,5 kg

ottica UGR19
UGR 19 optic

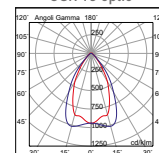

diffusore microprismato
microprismatic diffuser

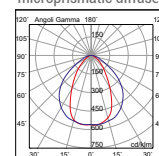

versione DALI 2 per tutti i codici
DALI 2 version available for all codes

esempio/example cod. **NAE003XXDA**

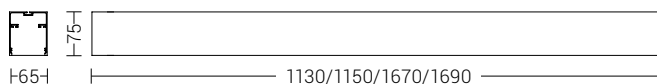



BIEMISSIONE MONTAGGIO IN LINEA DIRECT-INDIRECT LIGHT IN-LINE MOUNTING SYSTEM



Finiture Finishing



B - bianco white



N - nero black

Codice Code	Potenza Power	Flusso effettivo Real flux	Efficienza Efficiency	CCT	Dimensioni mm Dimensions mm	Peso Weight
OTTICA OPTIC UGR 19 						
Inizio linea / start line						
NAE203XX	25W+8W	3130+1305 lm	137 lm/W	3000K	1150x65 x 75	2,5 kg
NAE204XX	25W+8W	3254+1395 lm	143 lm/W	4000K	1150x65x75	2,5 kg
NAE207XX	37W+16W	4694+2610 lm	139 lm/W	3000K	1690x65x75	2,5 kg
NAE208XX	37W+16W	4882+2790 lm	146 lm/W	4000K	1690x65x75	2,5 kg
intermedio / intermediate						
NAE219XX	25W+8W	3130+1305 lm	137 lm/W	3000K	1130x65 x 75	2,5 kg
NAE220XX	25W+8W	3254+1395 lm	143 lm/W	4000K	1130x65x75	2,5 kg
NAE223XX	37W+16W	4694+2610 lm	139 lm/W	3000K	1670x65x75	2,5 kg
NAE224XX	37W+16W	4882+2790 lm	146 lm/W	4000K	1670x65x75	2,5 kg
fine linea / end line						
NAE211XX	25W+8W	3130+1305 lm	137 lm/W	3000K	1150x65 x 75	2,5 kg
NAE212XX	25W+8W	3254+1395 lm	143 lm/W	4000K	1150x65x75	2,5 kg
NAE215XX	37W+16W	4694+2610 lm	139 lm/W	3000K	1690x65x75	2,5 kg
NAE216XX	37W+16W	4882+2790 lm	146 lm/W	4000K	1690x65x75	2,5 kg
DIFFUSORE MICROPRISMATO MICROPRISMATIC DIFFUSER						
Inizio linea / start line						
NAE201XX	22W+8W	2412+1305 lm	126 lm/W	3000K	1150x65x75	2,5 kg
NAE202XX	22W+8W	2682+1395 lm	138 lm/W	4000K	1150x65x75	2,5 kg
NAE205XX	33W+15W	3618+2610 lm	129 lm/W	3000K	1690x65x75	2,5 kg
NAE206XX	33W+15W	4023+2790 lm	141 lm/W	4000K	1690x65x75	2,5 kg
intermedio / intermediate						
NAE217XX	22W+8W	2412+1305 lm	126 lm/W	3000K	1130x65x75	2,5 kg
NAE218XX	22W+8W	2682+1395 lm	138 lm/W	4000K	1130x65x75	2,5 kg
NAE221XX	33W+16W	3618+2610 lm	129 lm/W	3000K	1670x65x75	2,5 kg
NAE222XX	33W+15W	4023+2790 lm	141 lm/W	4000K	1670x65x75	2,5 kg
fine linea / end line						
NAE209XX	22W+8W	2412+1305 lm	126 lm/W	3000K	1150x65x75	2,5 kg
NAE210XX	22W+8W	2682+1395 lm	138 lm/W	4000K	1150x65x75	2,5 kg
NAE213XX	33W+15W	3618+2610 lm	129 lm/W	3000K	1690x65x75	2,5 kg
NAE214XX	33W+15W	4023+2790 lm	141 lm/W	4000K	1690x65x75	2,5 kg

ottica UGR19
UGR 19 optic

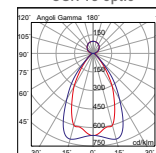

diffusore microprismato
microprismatic diffuser

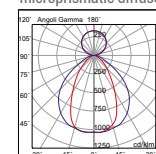

versione DALI 2 per tutti i codici
DALI 2 version available for all codes
esempio/example cod. **NAS403XXDA**

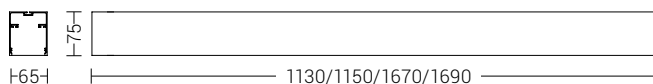

ACCESSORI ACCESSORIES

Kit sospensione Suspension Kit

Coppia di rosoni in ottone cromato con funi in acciaio
Carico massimo 7Kg
Pair of brass chrome ceiling rose with wire ropes
Maximum load 7Kg



Ø16mm - L:1500mm

Cod.

NAE904

Rosone copriforo Ceiling rose

Acciaio verniciato
Powder coated steel sheet



L:130mm La:40mm H:40mm

Cod.

NAE901B

NAE901N

Finitura Finishing

bianco white

nero black

Kit attacco a plafone per monoemissione Ceiling connection Kit for direct light emission

Coppia di staffe in lamiera verniciata
Fissaggio con viti
Pair of powder coated steel sheet brackets
Fixed with screws



Cod.

NAE902B

NAE902N

Finitura Finishing

bianco white

nero black

Giunto angolare (90°) cieco 90° blank angle joint

Alluminio
Fissaggio con viti
Aluminium
Fixed with screws



Cod.

NAE903B

NAE903N

Finitura Finishing

bianco white

nero black

Modulo cieco Blank module

Modulo cieco composto da un profilo in alluminio e relativa copertura inferiore in acciaio verniciato

Blank module with aluminium profile and its lower cover in painted steel



Cod.

NAE905B

NAE905N

Finitura Finishing

bianco white

nero black

ESEMPIO DI COMPOSIZIONE COMPOSITION EXAMPLE

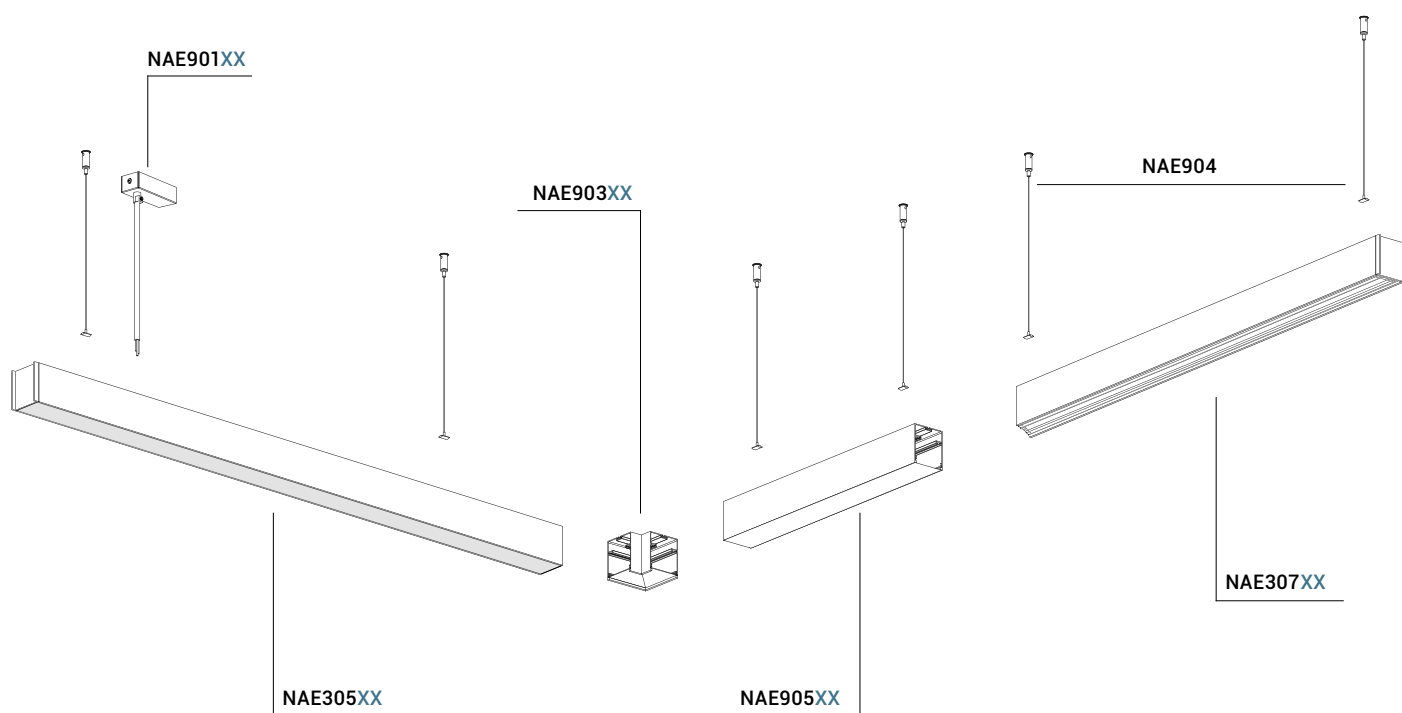

NUOVO GIUNTO LINEARE NEW LINEAR JUNCTION

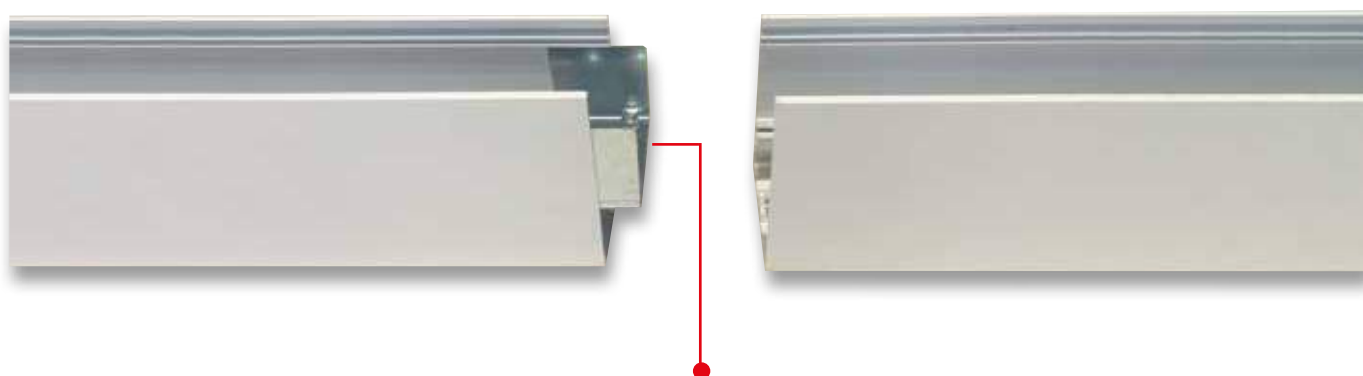

A differenza di altri prodotti presenti sul mercato, il nuovo sistema di giunzione lineare del Nashi evo è studiato appositamente per evitare i così detti "baffi di luce".

Unlike other products on the market, the Nashi evo's new linear junction system is specially designed to avoid the so called "moustaches of light".

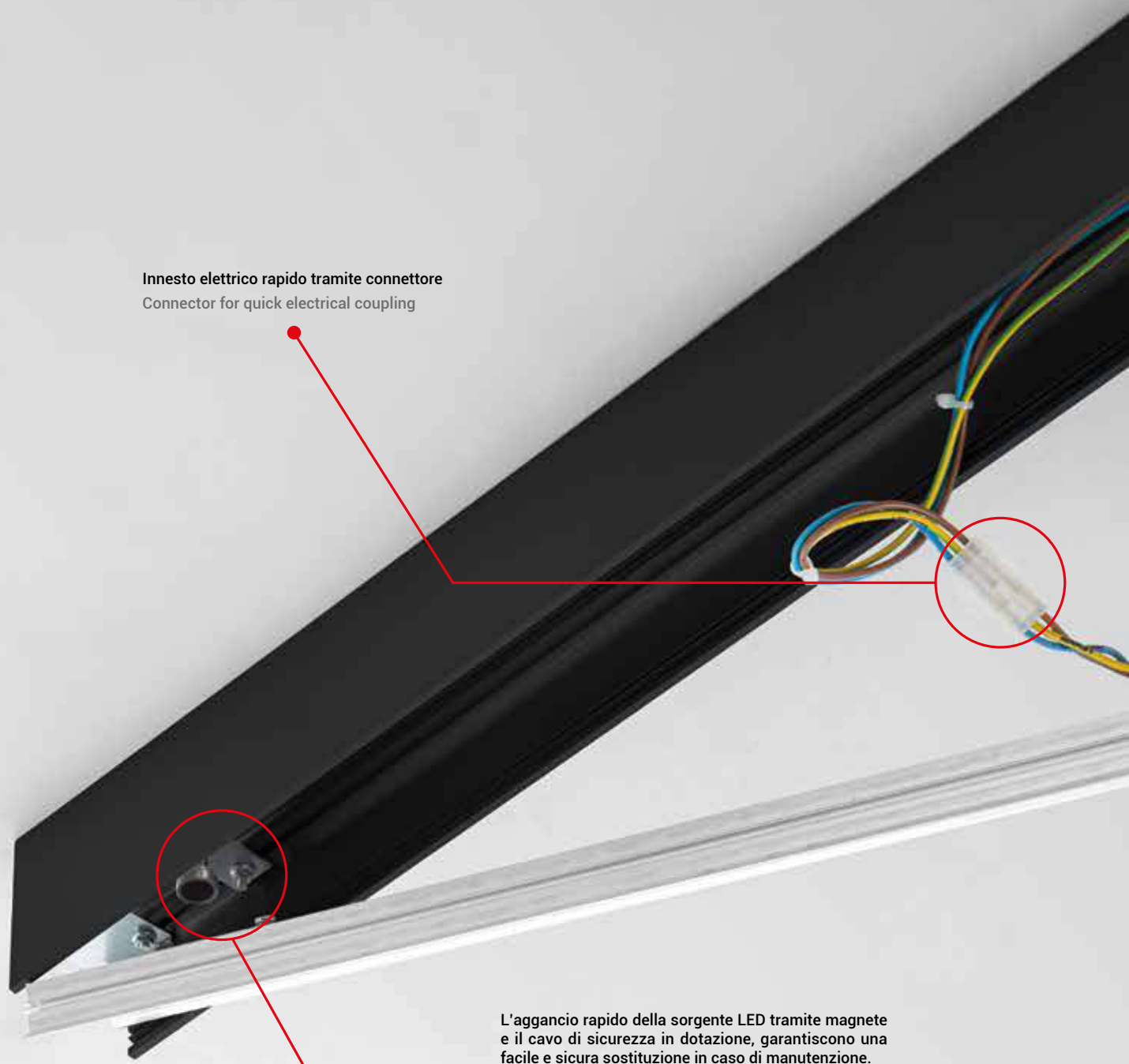

Innesto elettrico rapido tramite connettore
Connector for quick electrical coupling

L'aggancio rapido della sorgente LED tramite magnete e il cavo di sicurezza in dotazione, garantiscono una facile e sicura sostituzione in caso di manutenzione.

The quick connection of the LED source by magnet and the safety cable supplied, offer easy and safe replacement in case of maintenance.

NISO

RAFFINATA
TECNOLOGIA
FINEST
TECHNOLOGY

Dal design elegante e moderno, racchiude un'innovativa tecnologia che rende l'apparecchio idoneo per illuminare gli ambienti di lavoro, uffici e sale riunioni in modo corretto. E' composto da lastre micro-incise che adottano il sistema LGP, garantendo la perfetta diffusione della luce, omogenea e priva di fastidiosi effetti di abbagliamento, raggiungendo i requisiti UGR>19.

With an elegant and modern design, it contains an innovative technology that makes the luminaire suitable for illuminating work environments, offices and meeting rooms correctly. It is composed of micro-engraved plates that adopt the LGP system, ensuring the perfect diffusion of light, homogeneous and free of annoying glare effects, reaching the UGR>19 requirements.



Apparecchio biemissione a sospensione realizzato completamente in Italia, con materiali e componentistica di elevata qualità. Il corpo centrale è di alluminio estruso verniciato a polvere e i due diffusori laterali sono realizzati in PMMA trasparente.

Made in Italy LED luminaire for direct/indirect light emission for suspension installation, with high quality materials and components. Powder coating aluminium central spine and two laterals transparent PMMA reflectors..



Il Design.
Design.

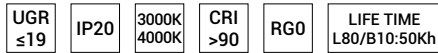
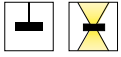

FINITURE FINISHES

Bianco gofrato. Verniciatura a polvere.
Embossed white. Powder coating.



Bianco White

SORGENTE SOURCE

Moduli LED ad elevate prestazioni
Made in Italy, disponibili in due temperature colore (3000K e 4000K), CRI>90.

Made in Italy high performance LED modules, available in two gradations (3000K and 4000K), CRI>90.

ELETTRIFICAZIONE POWER SUPPLY

220-240V. Gruppo di alimentazione incluso alloggiato nel rosone.

220-240V. Driver located in the ceiling rose included

EMISSIONE LUMINOSA LIGHT EMISSION

I moduli LED sono alloggiati nel profilo centrale e la luce viene convogliata lungo tutta la superficie diffondente grazie ad un innovativo metodo di lavorazione a laser chiamato LGP, una micro-incisione effettuata nel PMMA che garantisce un illuminamento omogeneo, morbido, senza riflessi e privo di abbagliamento con UGR>19. Da spento il prodotto risulta trasparente, da acceso diventa di un bianco pieno.

The PMMA reflectors translate the lateral light output of the LED boards into a direct and indirect direction thanks to a laser micro engraving, called LGP, on the reflector for an optimal low glare, uniform and soft light emission achieving UGR<19. When switch off the diffuser is transparent, when switch on turns to a solid white element.

CONTROLLO POWER SUPPLY

Disponibile nella versione dimmerabile con protocollo DALI.

Available in dimmable DALI version.

APPLICAZIONI ENVIRONMENTS

Apparecchio LED con innovativa tecnologia LGP che lo rende perfetto per ambienti di lavoro, uffici e sale riunioni dove è centrale illuminare correttamente gli ambienti, senza rinunciare al design.

LED luminaire with LGP innovative technology, that makes it perfect for work environments, offices and meeting rooms, where it is central to illuminate correctly the environments, without renounce design.

NORMATIVE REGULATIONS

EN 60598-1 (Apparecchi di illuminazione, prescrizioni generali)
EN 62471 (Rischio fotobiologico)
EN 12464-1 (Illuminazione dei luoghi di lavoro)
2014/35/UE (Direttiva bassa tensione)
2014/30/UE (Direttiva compatibilità elettromagnetica)

EN 60598-1 (Electric safety standards)
EN 62471 (Photobiological safety standards)
EN 12464-1 (Lighting of indoor workplaces)
2014/35/UE (Low Voltage Directive)
2014/30/UE (Electro-magnetic compatibility standards)

SU RICHIESTA UPON REQUEST

Finiture speciali.
Special finishes.

LGP (Light Guide Plate) è una particolare tecnologia luminosa basata su una lastra in resina di polimetilmetacrilato (PMMA) ad elevata purezza, sulla cui superficie viene micro-incisa una speciale matrice. La luce, convogliata lateralmente dalla fonte luminosa, si diffonde sulla lastra e viene distribuita uniformemente sulla superficie del pannello, ottenendo un illuminamento omogeneo, diffuso e privo di abbagliamento.

LGP (Light Guide Plate) is a particular light technology based on a high purity polymethylmethacrylate resin (PMMA) plate, on whose surface a special matrix is micro-engraved. The light, conveyed laterally from the light source, diffuses on the plate and is evenly distributed on the panel surface, obtaining a homogeneous, diffused and glare-free illumination.



SPENTO/OFF

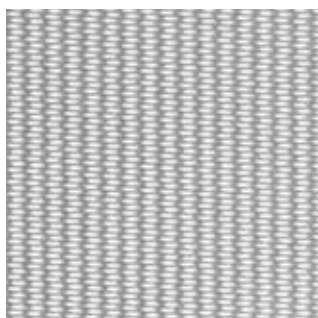

Lo studio del perfetto equilibrio del pattern è l'elemento fondamentale per creare un effetto luminoso efficiente.

The study of the perfect balance of the patterns is the essential element to create an efficient lighting effect.



ACCESO/ON

SOSPENSIONE SUSPENSION

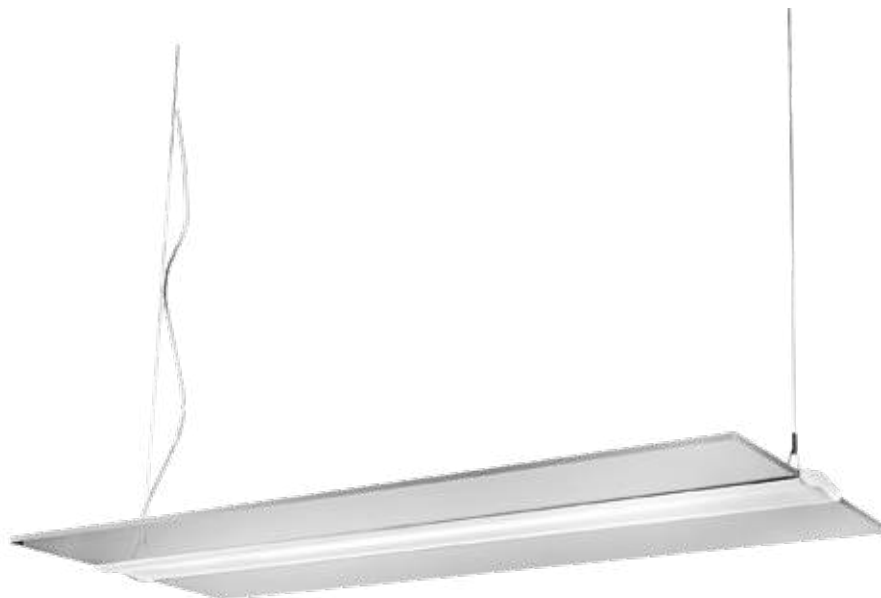

Finiture Finishing



bianco white

Codice Code	Potenza Power	Flusso effettivo Real flux	Efficienza Efficiency	CCT	Dimensioni mm Dimensions mm	Peso Weight
NIS103B	50W	2509 + 1673 lm	84 lm/W	3000K	1200 x 480 x 20	7,9 kg
NIS104B	50W	2723 + 1815 lm	91 lm/W	4000K	1200 x 480 x 20	7,9 kg
NIS105B	67W	3346 + 2231 lm	84 lm/W	3000K	1600 x 480 x 20	10,4 kg
NIS106B	67W	3631 + 2420 lm	91 lm/W	4000K	1600 x 480 x 20	10,4 kg

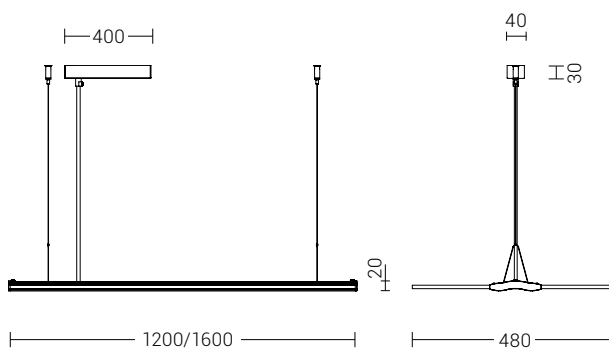
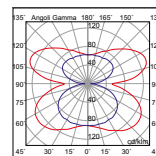

versione DALI per tutti i codici
DALI version available for all codes

esempio/example cod. **NIS003BDA**



BILL*evo*

LIFE TIME ELEVATO HIGH LIFE TIME

Una soluzione illuminotecnica robusta, duratura e performante: il corpo principale è realizzato in lamiera verniciata a polveri; la sorgente luminosa è dotata di una doppia ottica parabolica in alluminio lucidato a specchio, con copertura opale dei moduli, grazie alla quale si raggiunge un valore di UGR<19. Apparecchio LED in versione mono e biemissione da installare sia a plafone che a sospensione.

A strong, durable and high-performance lighting solution: powder coating sheet steel body. Double parabolic mirror-finished aluminium antireflection optic with opal PMMA diffuser, thanks to which a value of UGR<19. LED luminaire for direct or indirect light emission for ceiling and suspension installation.



Sorgente luminosa con moduli LED ad elevate prestazioni e una vita attesa di 80.000 ore. Consigliato nell'ambito della progettazione per uffici, scuole e aree con elevati requisiti di controllo della luce e dell'abbagliamento.

High performance LED modules and lifetime of 80.000 hours. Recommended for offices, schools and areas with high light and glare control requirements.



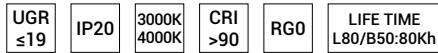

FINITURE FINISHES

Bianco. Verniciatura a polvere
White. Powder coating.



Bianco White

EMISSIONE LUMINOSA LIGHT EMISSION

Monoemissione a luce diretta e biemissione a luce diretta-indiretta. Le ottiche lamellari consentono il corretto controllo dell'abbagliamento garantendo un UGR<19.

LED luminaire for direct and direct/indirect light emission. The lamellar optics allow the correct glare control ensuring UGR<19.



NORMATIVE REGULATIONS

EN 60598-1 (Apparecchi di illuminazione, prescrizioni generali)
EN 62471 (Rischio fotobiologico)
EN 12464-1 (Illuminazione dei luoghi di lavoro)
2014/35/UE (Direttiva bassa tensione)
2014/30/UE (Direttiva compatibilità elettromagnetica).

EN 60598-1 (Electric safety standards)
EN 62471 (Photobiological safety standards)
EN 12464-1 (Lighting of indoor workplaces)
2014/35/UE (Low Voltage Directive)
2014/30/UE (Electro-magnetic compatibility standards).

SORGENTE SOURCE

Moduli LED ad elevate prestazioni disponibili in due temperature colore (3000K e 4000K), CRI>90 e una vita attesa di 80.000 ore.

High performance LED modules available in two gradations (3000K and 4000K), CRI>90 and lifetime of 80.000 hours.

ELETRIFICAZIONE POWER SUPPLY

220-240V. Gruppo di alimentazione integrato, montato a bordo dell'apparecchio.

220-240V. On board driver.

CONTROLLO POWER SUPPLY

Disponibile nella versione dimmerabile con protocollo DALI, emergenza 3h, DALI/emergenza.

Available in dimmable DALI, emergency 3h, DALI/emergency version.

APPLICAZIONI ENVIRONMENTS

Grazie all'ottimale controllo dell'abbagliamento, è altamente consigliato per uffici, aree con elevati requisiti di controllo della luce e dell'abbagliamento e ambienti con videotermini.

Thanks to the optimal glare control, it's recommended for workstations and offices, high lighting and glare control requirements areas and VDU environments.

SU RICHIESTA UPON REQUEST

Versione in emergenza 3h. Versione con sensore ambientale vedi pag. 92

Emergency version 3h. Environmental sensor version see pag. 92

MONOEMISSIONE DIRECT LIGHT

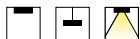

Codice Code	Potenza Power	Flusso effettivo Real flux	Efficienza Efficiency	CCT	Dimensioni mm Dimensions mm	Peso Weight
BIL501B	37W	3980 lm	108 lm/W	3000K	1245 x 245 x 55	4,0 kg
BIL502B	37W	4100 lm	111 lm/W	4000K	1245 x 245 x 55	4,0 kg
BIL503B	58W	6350 lm	110 lm/W	3000K	1545 x 245 x 55	5,0 kg
BIL504B	58W	6550 lm	113 lm/W	4000K	1545 x 245 x 55	5,0 kg

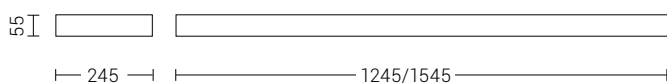

attacco a plafone incluso
ordinare separatamente il kit sospensione e il
rosone elettrificato (vedi pag. 43).

ceiling kit included.
order the suspension kit and electrified rose
separately (see page 43).

versione DALI, EMERGENZA, EMERGENZA DALI e SENSORE AMBIENTALE per tutti i codici
DALI, EMERGENCY, DALI EMERGENCY and ENVIRONMENTAL SENSOR version available for all codes

esempio/example cod. **BIL501BDA - BIL501BEM3 - BIL501BEM3DA - BIL501BSM**

Finiture Finishing



B - bianco white

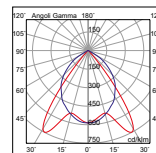

BIEMISSIONE DIRECT-INDIRECT LIGHT



Codice Code	Potenza Power	Flusso effettivo Real flux	Efficienza Efficiency	CCT	Dimensioni mm Dimensions mm	Peso Weight
BIL521B	37W + 19W	3980 + 1640 lm	101 lm/W	3000K	1245 x 245 x 55	4,0 kg
BIL522B	37W + 19W	4100 + 1700 lm	104 lm/W	4000K	1245 x 245 x 55	4,0 kg
BIL523B	58W + 21W	6350 + 2180 lm	108 lm/W	3000K	1545 x 245 x 55	5,0 kg
BIL524B	58W + 21W	6550 + 2250 lm	112 lm/W	4000K	1545 x 245 x 55	5,0 kg

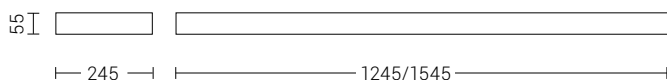

ordinare separatamente il rosone elettrificato
(vedi pag. 43).

order the electrified rose separately (see page 43).

versione DALI, EMERGENZA, EMERGENZA DALI e SENSORE AMBIENTALE per tutti i codici
DALI, EMERGENCY, DALI EMERGENCY and ENVIRONMENTAL SENSOR version available for all codes

esempio/example cod. **BIL521BDA - BIL521BEM3 - BIL521BEM3DA - BIL521BSM**

Finiture Finishing



B - bianco white

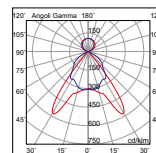



ACCESSORI ACCESSORIES

Kit sospensione Suspension Kit

Coppia di rosoni in ottone cromato con funi in acciaio di 1500mm. Dispositivo per regolazione millimetrica. Carico massimo 7Kg per fune.

Pair of brass chrome ceiling rose, with wire ropes 1500mm. Device for millimetric regulation. Maximum load 7Kg per rope.

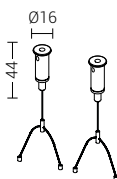

Cod.

BIL500MT

Rosone elettrificato per sospensione ON-OFF e DALI Electrified ceiling rose for ON-OFF and DALI suspension

Rosone in lamiera verniciata con morsetto e cavo di alimentazione trasparente (3x1,5mm²), lunghezza max 1600mm.

Powder coated sheet steel ceiling rose with clip and transparent power cable (3x1,5mm²), max length 1600mm.

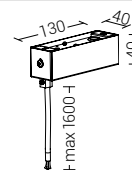

Cod.

BIL901B (per sospensione for suspension ON-OFF)

BILL901BDA (per sospensione for suspension DALI)



MÓN

CROMATISMO
& STILE
CHROMATISM
& STYLE

Prodotto di illuminazione dedicato al mondo architettonico, adatto agli spazi di accoglienza ed incontro. Il diffusore microprismatico con distribuzione della luce diretta o diretta/indiretta offre un'emissione ottimale e uniforme della luce senza abbagliamenti e ombre, per un'atmosfera ospitale che favorisce il benessere delle persone.

Lighting product to the architectural world, suitable for reception and meeting spaces. The microprismatic diffuser for direct or direct/indirect lighting emission offer an optimal and uniform diffusion of light without glare and shadows for a hospitable atmosphere that promotes the well-being of people.



Lampada a LED versatile e adatta a diversi ambiti; sia per la doppia installazione, soffitto e plafone, sia per la possibilità di personalizzarla con colori e dimensioni ad hoc, oltre alle due misure e finiture standard. Struttura in estruso di alluminio.

LED lamp versatile and suitable for different environments; both for the double installation, ceiling and suspension, both for the customize in size and colour, in addition to the standard versions. Extruded aluminium structure.

**Personalizzazione.
Customization.**



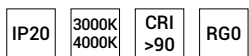

FINITURE FINISHES

Bianco e nero. Verniciatura a polvere.
White and black. Powder coating.



Bianco White



Nero Black

EMISSIONE LUMINOSA LIGHT EMISSION

Monoemissione a luce diretta e
biemissione a luce diretta-indiretta
LED luminaire for direct and direct/
indirect light emission.



NORMATIVE REGULATIONS

EN 60598-1 (Apparecchi di illuminazione, prescrizioni generali)
EN 62471 (Rischio fotobiologico)
EN 12464-1 (Illuminazione dei luoghi di lavoro)
2014/35/UE (Direttiva bassa tensione)
2014/30/UE (Direttiva compatibilità elettromagnetica)

EN 60598-1 (Electric safety standards)
EN 62471 (Photobiological safety standards)
EN 12464-1 (Lighting of indoor workplaces)
2014/35/UE (Low Voltage Directive)
2014/30/UE (Electro-magnetic compatibility standards)

SORGENTE SOURCE

Moduli LED ad elevate prestazioni
disponibili in due temperature colore
(3000K e 4000K), CRI>90.

High performance LED modules
available in two gradations (3000K
and 4000K), CRI>90.

ELETRIFICAZIONE POWER SUPPLY

220-240V. Gruppo di alimentazione
incluso alloggiato nel rosone.

220-240V. Driver located in the
ceiling rose included.

CONTROLLO POWER SUPPLY

Disponibile nella versione dimmerabile
con protocollo DALI.

Available in dimmable DALI version.

APPLICAZIONI ENVIRONMENTS

Grazie al suo design elegante e alla
sua efficienza energetica è perfetta
per illuminare aree di accoglienza
per hotel e retail, spazi horeca, zone
di socializzazione, nonché ambiti
residenziali.

Thanks to its elegant design and
its excellent colour rendering, it is
suitable for reception areas, hotels
and retail, horeca and social areas,
as well as residential areas.

SU RICHIESTA UPON REQUEST

Finiture e misure speciali.

Special finishes and sizes.

PLAFONE CEILING



Codice Code	Potenza Power	Flusso effettivo Real flux	Efficienza Efficiency	CCT	Dimensioni mm Dimensions mm	Peso Weight
MNN003XX	50W	6000 lm	120 lm/W	3000K	Ø580 x 35	7 kg
MNN004XX	50W	6250 lm	125 lm/W	4000K	Ø580 x 35	7 kg
MNN007XX	80W	9600 lm	120 lm/W	3000K	Ø780 x 35	9 kg
MNN008XX	80W	10000 lm	125 lm/W	4000K	Ø780 x 35	9 kg

versione DALI per tutti i codici
DALI version available for all codes

esempio/example cod. **MNN003BDA**

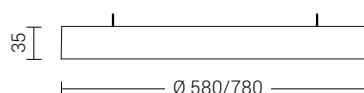

Finiture Finishing



B - bianco white



N - nero black

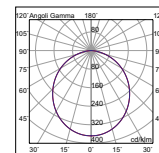

SOSPENSIONE SUSPENSION



Codice Code	Potenza Power	Flusso effettivo Real flux	Efficienza Efficiency	CCT	Dimensioni mm Dimensions mm	Peso Weight
MONOEMISSIONE / DIRECT LIGHT						
MNN001XX	50W	6000 lm	120 lm/W	3000K	Ø580 x 35	7 kg
MNN002XX	50W	6250 lm	125 lm/W	4000K	Ø580 x 35	7 kg
MNN005XX	80W	9600 lm	120 lm/W	3000K	Ø780 x 35	9 kg
MNN006XX	80W	10000 lm	125 lm/W	4000K	Ø780 x 35	9 kg

BIEMISSIONE / DIRECT-INDIRECT LIGHT

MNN009XX	50W + 40W	6000 + 4800 lm	120 lm/W	3000K	Ø600 x 75	10 kg
MNN010XX	50W + 40W	6250 + 5000 lm	125 lm/W	4000K	Ø600 x 75	10 kg

versione DALI per tutti i codici
DALI version available for all codes

esempio/example cod. **MNN001NDA**

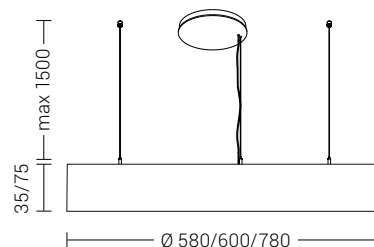

Finiture Finishing



B - bianco white



N - nero black

monoemissione

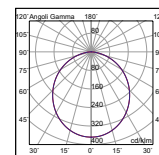

biemissione

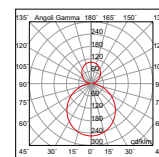





CERCLE

LUMINOSITÀ SENZA TEMPO TIMELESS BRIGHTNESS

Design attuale, forma armonica, duttilità del prodotto e un'alta prestazione di durata nel tempo, fanno di questa lampada una soluzione perfetta per progetti illuminotecnici in cui l'affidabilità è la parola chiave. La possibilità di installare il corpo a differenti altezze, creare giochi di luce e scenografie permette di realizzare concept originali ed elaborati.

Modern design, harmonic shape, ductility of the product and a high performance over time, make this lamp a perfect solution for lighting projects where reliability is the keyword. It can be installed at different heights, to create games of light and scenography for original and elaborate concepts.



Struttura ad anello in alluminio e diffusore opale per un'emissione ottimale e uniforme della luce senza abbagliamenti e ombre. Disponibile per installazione a plafone e a sospensione, in due misure e finiture differenti con la possibilità di richiedere prodotti customizzati per rispondere alle esigenze di ogni progetto.

Ring aluminium body and opal diffuser for diffused light emission without glare and shadows. Available for ceiling and suspension installation, in two sizes and finishes with the possibility to request customized products to meet the needs of each project.



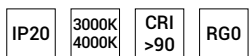

FINITURE FINISHES

Bianco e nero. Verniciatura a polvere.
White and black. Powder coating.



Bianco White



Nero Black

EMISSIONE LUMINOSA LIGHT EMISSION

Monoemissione a luce diretta e
biemissione a luce diretta-indiretta.
LED luminaire for direct and direct/
indirect light emission with.



NORMATIVE REGULATIONS

EN 60598-1 (Apparecchi di illuminazione, prescrizioni generali)
EN 62471 (Rischio fotobiologico)
EN 12464-1 (Illuminazione dei luoghi di lavoro)
2014/35/UE (Direttiva bassa tensione)
2014/30/UE (Direttiva compatibilità elettromagnetica)

EN 60598-1 (Electric safety standards)
EN 62471 (Photobiological safety standards)
EN 12464-1 (Lighting of indoor workplaces)
2014/35/UE (Low Voltage Directive)
2014/30/UE (Electro-magnetic compatibility standards)

SORGENTE SOURCE

Moduli LED ad elevate prestazioni
disponibili in due temperature colore
(3000K e 4000K), CRI>90.
High performance LED modules
available in two gradations (3000K
and 4000K), CRI>90.

ELETRIFICAZIONE POWER SUPPLY

220-240V. Gruppo di alimentazione
incluso alloggiato nel rosone.
220-240V. Driver located in the
ceiling rose included.

CONTROLLO POWER SUPPLY

Disponibile nella versione dimmerabile
con protocollo DALI.
Available in dimmable DALI version.

APPLICAZIONI ENVIRONMENTS

Grazie al suo design minimal e alla
sua efficienza energetica è perfetto
per illuminare in modo elegante
hotel, reception, aree d'attesa, sale
riunioni, ristoranti e ambiti retail.
Thanks to its minimal design and
its excellent colour rendering,
it is suitable for lighting hotels,
receptions, lounges, meeting areas,
restaurants and retail areas.

SU RICHIESTA UPON REQUEST

Finiture e misure speciali.
Special finishes and sizes.

PLAFONE CEILING



Codice Code	Potenza Power	Flusso effettivo Real flux	Efficienza Efficiency	CCT	Dimensioni mm Dimensions mm	Peso Weight
CER003XX	43W	3950 lm	92 lm/W	3000K	Ø600 x 35	3 kg
CER004XX	43W	4117 lm	96 lm/W	4000K	Ø600 x 35	3 kg
CER007XX	87W	7900 lm	91 lm/W	3000K	Ø1200 x 35	6 kg
CER008XX	87W	8233 lm	95 lm/W	4000K	Ø1200 x 35	6 kg

versione DALI per tutti i codici
DALI version available for all codes

esempio/example cod. **CER003BDA**

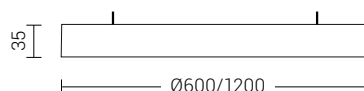

Finiture Finishing



B - bianco white



N - nero black

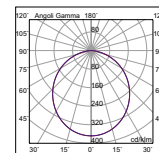

SOSPENSIONE SUSPENSION



Codice Code	Potenza Power	Flusso effettivo Real flux	Efficienza Efficiency	CCT	Dimensioni mm Dimensions mm	Peso Weight
MONOEMISSIONE / DIRECT LIGHT						
CER001XX	43W	3950 lm	92 lm/W	3000K	Ø600 x 35	3 kg
CER002XX	43W	4117 lm	96 lm/W	4000K	Ø600 x 35	3 kg
CER005XX	87W	7900 lm	91 lm/W	3000K	Ø1200 x 35	6 kg
CER006XX	87W	8233 lm	95 lm/W	4000K	Ø1200 x 35	6 kg
BIEMISSIONE / DIRECT-INDIRECT LIGHT						
CER009XX	43W+22W	3950+1665 lm	87 lm/W	3000K	Ø600 x 75	3 kg
CER010XX	43W+22W	4117+1733 lm	90 lm/W	4000K	Ø600 x 75	3 kg
CER011XX	87W+43W	7900+3330 lm	87 lm/W	3000K	Ø1200 x 75	6 kg
CER012XX	87W+43W	8233+3467 lm	90 lm/W	4000K	Ø1200 x 75	6 kg

versione DALI per tutti i codici
DALI version available for all codes

esempio/example cod. **CER001BDA**

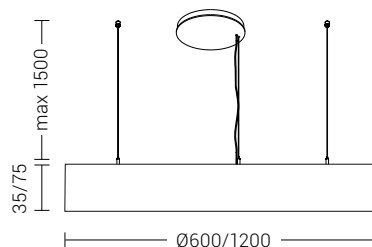

Finiture Finishing



B - bianco white



N - nero black

monoemissione

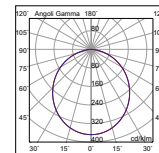

biemissione

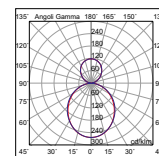





KANT

ELEGANZA
VERSATILE
VERSATILE
ELEGANCE

La luce che dipinge atmosfere, trasformando gli spazi in emozionanti paesaggi luminosi. Una forma armonica e una luce indiretta che avvolge gli ambienti per creare confort alle persone, non solo visivo. Proposto in due diverse misure con montaggio a soffitto o a sospensione, è adatta agli spazi più accoglienti e di grande impatto scenico.

The light paints atmospheres, transforming spaces into exciting bright landscapes. A harmonious shape and an indirect light envelop the environments to create comfort to people, not only visual. Available in two different sizes with ceiling or suspension installation, it is suitable for the most reception areas and of great scenic impact.



Struttura in alluminio e diffusore circolare opale con moduli LED di ultima generazione per un'illuminazione diffusa nell'ambiente. Disponibile bianca o nera e personalizzabile in differenti colori e dimensioni.

Aluminium body and opal diffuser with LED modules for diffused light emission without glare and shadows. Available in white or black and customizable in different colours and sizes.



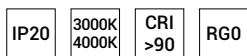

FINITURE FINISHES

Bianco e nero. Verniciatura a polvere.
White and black. Powder coating.



Bianco White



Nero Black

EMISSIONE LUMINOSA LIGHT EMISSION

Monoemissione a luce diretta.
LED luminaire for direct light emission.



NORMATIVE REGULATIONS

EN 60598-1 (Apparecchi di illuminazione, prescrizioni generali)
EN 62471 (Rischio fotobiologico)
EN 12464-1 (Illuminazione dei luoghi di lavoro)
2014/35/UE (Direttiva bassa tensione)
2014/30/UE (Direttiva compatibilità elettromagnetica)

EN 60598-1 (Electric safety standards)
EN 62471 (Photobiological safety standards)
EN 12464-1 (Lighting of indoor workplaces)
2014/35/UE (Low Voltage Directive)
2014/30/UE (Electro-magnetic compatibility standards)

SORGENTE SOURCE

Moduli LED ad elevate prestazioni disponibili in due temperature colore (3000K e 4000K), CRI>90.

High performance LED modules available in two gradations (3000K and 4000K), CRI>90.

ELETRIFICAZIONE POWER SUPPLY

220-240V. Gruppo di alimentazione incluso alloggiato nel rosone.

220-240V. Driver located in the ceiling rose included.

CONTROLLO POWER SUPPLY

Disponibile nella versione dimmerabile con protocollo DALI.

Available in dimmable DALI version.

APPLICAZIONI ENVIRONMENTS

Grazie al suo design minimal si adatta perfettamente ad ogni stile di ambiente, sia in ambito horeca che retail; sia per aree di socializzazione o di attesa che in luoghi di lavoro, nonché per abitazioni moderne.

Thanks to its simple design it fits perfectly in any style and environment: in horeca and retail areas, in socialization or waiting areas and in the workplace, as well as for modern homes.

SU RICHIESTA UPON REQUEST

Finiture e misure speciali.

Special finishes and sizes.

PLAFONE CEILING



Codice Code	Potenza Power	Flusso effettivo Real flux	Efficienza Efficiency	CCT	Dimensioni mm Dimensions mm	Peso Weight
KNT003XX	69W	5965 lm	87 lm/W	3000K	Ø800x47	4 kg
KNT004XX	69W	6217 lm	91 lm/W	4000K	Ø800x47	4 kg
KNT007XX	104W	8950 lm	87 lm/W	3000K	Ø1200x47	6 kg
KNT008XX	104W	9326 lm	90 lm/W	4000K	Ø1200x47	6 kg

versione DALI per tutti i codici
DALI version available for all codes

esempio/example cod.**KNT003BDA**

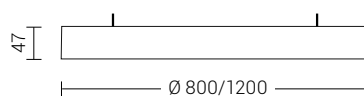

Finiture Finishing



B - bianco white



N - nero black

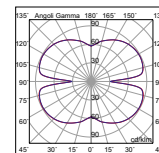

SOSPENSIONE SUSPENSION



Codice Code	Potenza Power	Flusso effettivo Real flux	Efficienza Efficiency	CCT	Dimensioni mm Dimensions mm	Peso Weight
KNT001XX	69W	5965 lm	87 lm/W	3000K	Ø800x47	4 kg
KNT002XX	69W	6217 lm	91 lm/W	4000K	Ø800x47	4 kg
KNT005XX	104W	8950 lm	87 lm/W	3000K	Ø1200x47	6 kg
KNT006XX	104W	9326 lm	90 lm/W	4000K	Ø1200x47	6 kg

versione DALI per tutti i codici
DALI version available for all codes

esempio/example cod.**KNT001NDA**

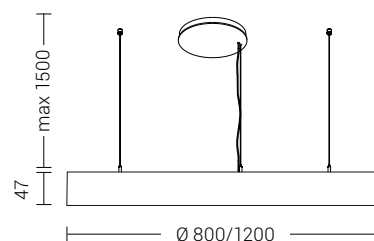

Finiture Finishing



B - bianco white



N - nero black

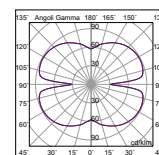

Progettazione.
Project.





DRACMA *evo*

SEMPLICITÀ
FUNZIONALE
FUNCTIONAL
SIMPLICITY

Pannello LED a luce diretta, dal design super sottile, adatto ad installazioni in controsoffitti modulari con struttura a vista. Il corpo è realizzato con un profilo di alluminio estruso e il diffusore in PMMA anti-ingiallimento ad alta trasmittanza. Quadrato o rettangolare; ad incasso, plafone o sospensione, è una soluzione semplice e funzionale per ogni ambiente lavorativo.

LED panel for direct light emission, super thin design, suitable to be installed on modular false ceilings with exposed structure. Extruded aluminium body and PMMA anti-yellowing diffuser with high transmittance.

Square or rectangular; recessed, surface or suspended mounted, it is a simple and functional solution for any work environment.





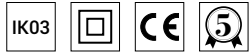
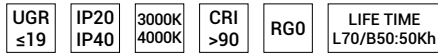

FINITURE FINISHES

Bianco. Verniciatura a polvere.
White. Powder coating.



Bianco White

EMISSIONE LUMINOSA LIGHT EMISSION

Monoemissione a luce diretta con
UGR<19.
LED luminaire for direct light
emission with UGR<19.



NORMATIVE REGULATIONS

EN 60598-1 (Apparecchi di illuminazione, prescrizioni generali)
EN 62471 (Rischio fotobiologico)
EN 12464-1 (Illuminazione dei luoghi di lavoro)
2014/35/UE (Direttiva bassa tensione)
2014/30/UE (Direttiva compatibilità elettromagnetica)

EN 60598-1 (Electric safety standards)
EN 62471 (Photobiological safety standards)
EN 12464-1 (Lighting of indoor workplaces)
2014/35/UE (Low Voltage Directive)
2014/30/UE (Electro-magnetic compatibility standards).

SORGENTE SOURCE

Moduli LED ad elevate prestazioni
disponibili in due temperature colore
(3000K e 4000K), CRI>90 e una vita
attesa di 50.000 ore.

High performance LED modules
available in two gradations (3000K
and 4000K), CRI>90 and lifetime of
50.000 hours.

ELETTRIFICAZIONE POWER SUPPLY

220-240V. Gruppo di alimentazione
incluso, da installare in remoto.

220-240V. Remote driver included.

CONTROLLO POWER SUPPLY

Disponibile nella versione dimmerabile
con protocollo DALI.

Available in dimmable DALI version.

APPLICAZIONI ENVIRONMENTS

Grazie alle alte prestazioni è ideale
per uffici e per il settore retail.

Thanks to high performance, it's
perfect for offices and retail sector.

SU RICHIESTA UPON REQUEST

Kit di emergenza 3h da installare in remoto.
Remote emergency kit with 3 hours battery life.

INCASSO/PLAFONE/SOSPENSIONE RECESSED/CEILING/SUSPENSION

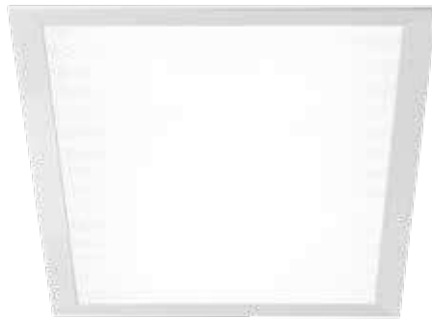

Finiture Finishing



bianco white

Codice Code	Potenza Power	Flusso effettivo Real flux	Efficienza Efficiency	CCT	Dimensioni mm Dimensions mm	Peso Weight
DRC108	30W	3440 lm	115 lm/W	3000K	595x595x8	3,8 kg
DRC107	30W	3600 lm	120 lm/W	4000K	595x595x8	3,8 kg

versione DALI per tutti i codici
DALI version available for all codes

esempio/example cod. **DRC107DA**

per versione in emergenza ordinare a parte:
for emergency version to be ordered separately

cod. EM3H

Kit emergenza Emergency kit 3H
220-240V - 50/60HZ - 7,2V/1,6m Ah.

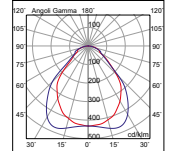
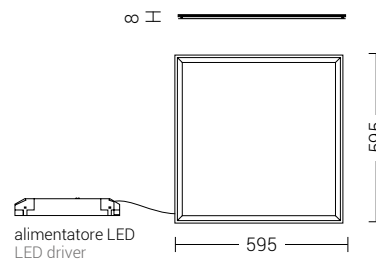

INCASSO/PLAFONE/SOSPENSIONE RECESSED/CEILING/SUSPENSION



Finiture Finishing



bianco white

Codice Code	Potenza Power	Flusso effettivo Real flux	Efficienza Efficiency	CCT	Dimensioni mm Dimensions mm	Peso Weight
DRC110	30W	3440 lm	115 lm/W	3000K	295x1195x8	3,8 kg
DRC109	30W	3600 lm	120 lm/W	4000K	295x1195x8	3,8 kg

versione DALI per tutti i codici
DALI version available for all codes

esempio/example cod. **DRC109DA**

per versione in emergenza ordinare a parte:
for emergency version to be ordered separately

cod. EM3H

Kit emergenza Emergency kit 3H
220-240V - 50/60HZ - 7,2V/1,6m Ah.

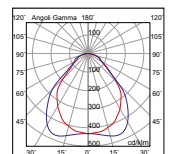
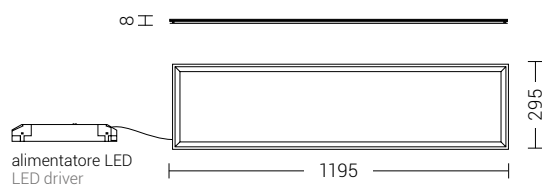

ACCESSORI ACCESSORIES

Kit sospensione (DRACMA 600x600 - 300x1200) Suspension Kit (DRACMA 600x600 - 300x1200)

4 tiranti in acciaio con rosoni cromati
4 steel ropes with chrome ceiling roses

Ø16x44
L. 1500 mm

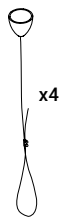

Cod.

DRC501MT

Telaio per installazione in cartongesso (DRACMA 600x600) Frame for recessed installation (DRACMA 600x600)

Lamiera verniciata bianca
White coated steel sheet

L:625 mm La:625 mm H:25 mm

▽ foro: 609x609 mm

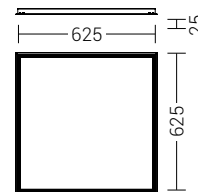

Cod.

DRC501PLAST

Cornice per attacco a plafone (DRACMA 600x600) Frame for ceiling fitting (DRACMA 600x600)

Lamiera verniciata bianca
White coated steel sheet

L:595 mm La:595 mm H:35 mm

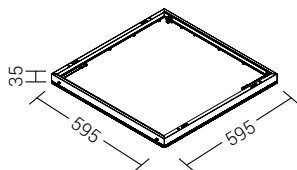

Cod.

DRC501FR

Telaio per installazione in cartongesso (DRACMA 300x1200) Frame for recessed installation (DRACMA 300x1200)

Lamiera verniciata bianca
White coated steel sheet

L:1225 mm La:325 mm H:25 mm

▽ foro: 1208x309 mm

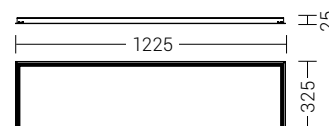

Cod.

DRC505PLAST

Cornice per attacco a plafone (DRACMA 300x1200) Frame for ceiling fitting (DRACMA 300x1200)

Lamiera verniciata bianca
White coated steel sheet

L:1195 mm La:295 mm H:35 mm

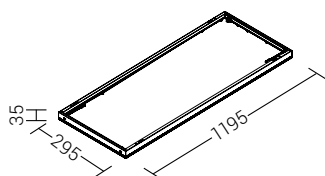

Cod.

DRC505FR

Molle installazione cartongesso (DRACMA 600x600 - 300x1200) Springs for plasterboard (DRACMA 600x600 - 300x1200)

Molle in alluminio per installazione ad
incasso su cartongesso

Aluminium springs for plasterboard
recessed installation



Cod.

DRC501SP

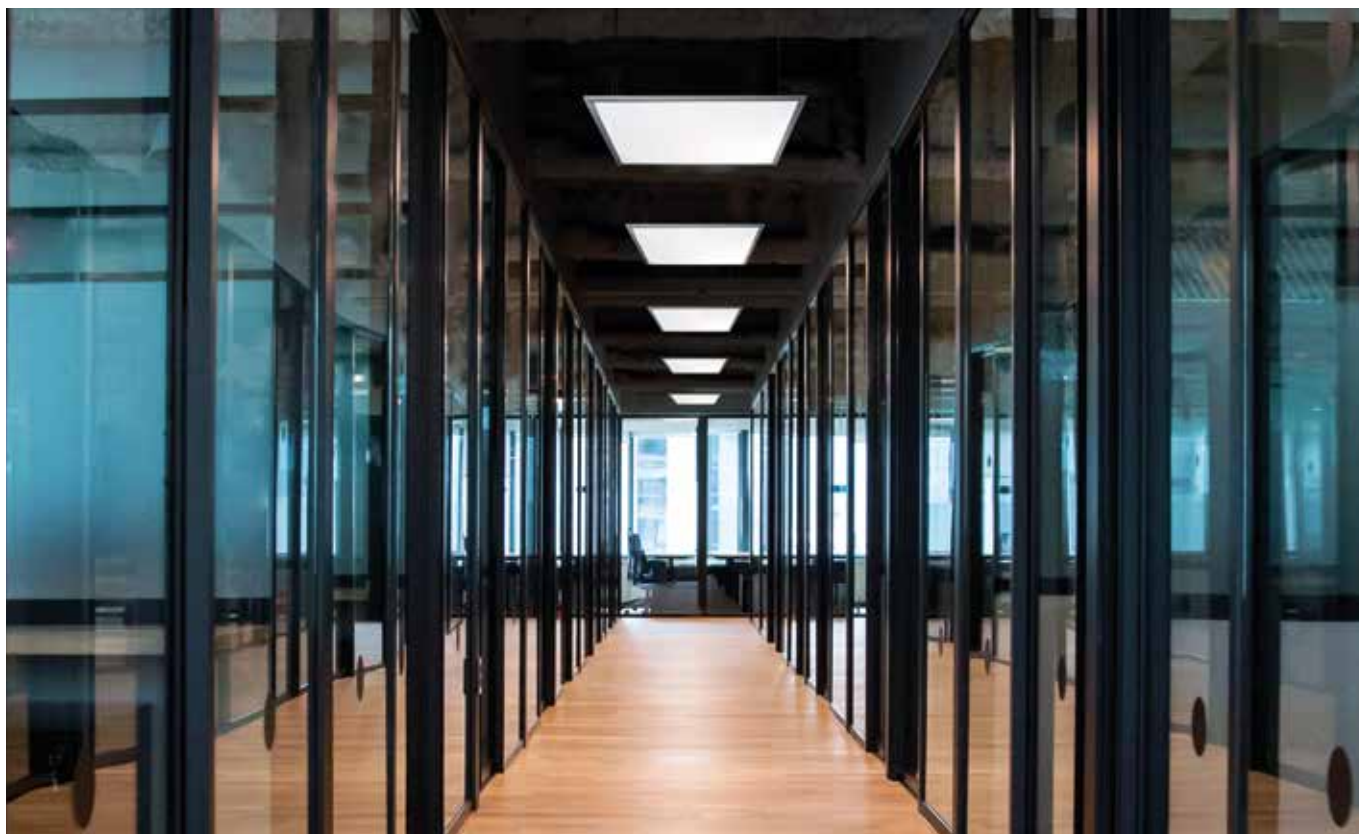



OPTIKA

LUCE CONTROLLATA CONTROLLED LIGHT

Nuova generazione di pannelli a luce diretta, dal design elegante e sottile. A differenza dei normali pannelli LED 60x60 è utilizzato un sistema del controllo della luce con lenti che permettono di avere un'illuminazione focalizzata dove è necessario.

New generation of panels for direct light emission with elegant and slim design. As opposed to other normal 60x60 LED panels, there is a light control system with lenses that allow to have focused lighting where it is needed.



L'apparecchio è costruito in lamiera verniciata a polvere, mentre il sistema di lenti direzionali ad elevate prestazioni in materiale PMMA. Idoneo per essere installato direttamente nei controsoffitti con struttura a vista oppure in cartongesso, sia ad incasso che a plafone, è ideale per ambienti lavorativi, grazie al controllo dell'abbagliamento.

The luminaire is made of powder coated sheet metal, while the directional lenses system with high performance PMMA material. Suitable for recessed mounting on modular false ceilings with exposed structure, and in plasterboard surface and ceiling installation, both recessed and surface-mounted, it's ideal for working environment thanks to its glare control.



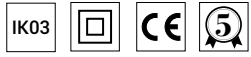

FINITURE FINISHES

Bianco. Verniciatura a polvere.
White. Powder coating.



Bianco White

EMISSIONE LUMINOSA LIGHT EMISSION

Monoemissione a luce diretta, lenti direzionali da 60° e UGR<19.

LED luminaire for direct light emission, directional lenses from 60° and UGR<19.



NORMATIVE REGULATIONS

EN 60598-1 (Apparecchi di illuminazione, prescrizioni generali)
EN 62471 (Rischio fotobiologico)
EN 12464-1 (Illuminazione dei luoghi di lavoro)
2014/35/UE (Direttiva bassa tensione)
2014/30/UE (Direttiva compatibilità elettromagnetica).

EN 60598-1 (Electric safety standards)
EN 62471 (Photobiological safety standards)
EN 12464-1 (Lighting of indoor workplaces)
2014/35/UE (Low Voltage Directive)
2014/30/UE (Electro-magnetic compatibility standards).

SORGENTE SOURCE

La sorgente luminosa è realizzata con moduli LED ad elevate prestazioni, disponibili in due temperature colore (3000K e 4000K), CRI>90 e una vita attesa eccezionale di 80.000 ore.

High performance LED modules available in two gradations (3000K and 4000K), CRI>90 and lifetime of 80.000 hours.

ELETTRIFICAZIONE POWER SUPPLY

220-240V. Gruppo di alimentazione incluso, da installare in remoto.

220-240V. Remote driver included.

CONTROLLO POWER SUPPLY

Disponibile nella versione dimmerabile con protocollo DALI.

Available in dimmable DALI version.

APPLICAZIONI ENVIRONMENTS

Grazie al perfetto controllo dell'abbagliamento è ideale per uffici, per il settore retail e per illuminare aree comuni e corridoi.

Thanks to its perfect glare control, it's ideal for offices, retail sector and for lighting public areas and corridors.

SU RICHIESTA UPON REQUEST

Versione con sensore ambientale vedi pag. 92

Environmental sensor version see pag. 92

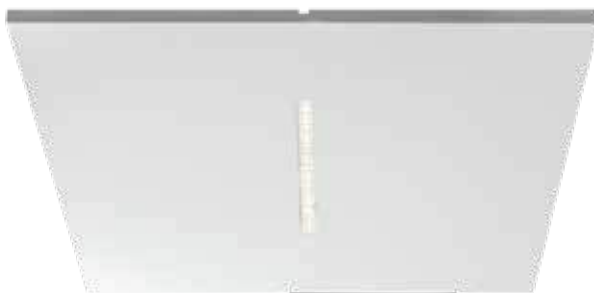

Finiture Finishing



B-bianco white

Codice Code	Potenza Power	Flusso effettivo Real flux	Efficienza Efficiency	CCT	Dimensioni mm Dimensions mm	Peso Weight
OPT001	10W	1260 lm	126 lm/W	3000K	596x596x15	2,0 kg
OPT002	10W	1300 lm	130 lm/W	4000K	596x596x15	2,0 kg

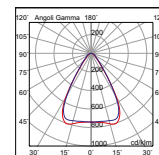

versione DALI e SENSORE AMBIENTALE per tutti i codici
DALI and ENVIRONMENTAL SENSOR version available for all codes

esempio/example cod.**OPT001DA - OPT001SM**

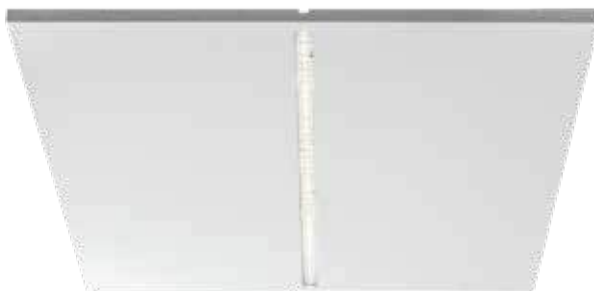
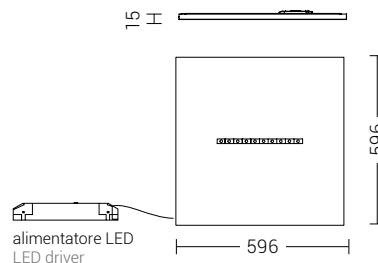

Finiture Finishing



B-bianco white

Codice Code	Potenza Power	Flusso effettivo Real flux	Efficienza Efficiency	CCT	Dimensioni mm Dimensions mm	Peso Weight
OPT003	19W	2620 lm	138 lm/W	3000K	596x596x15	2,0 kg
OPT004	19W	2700 lm	143 lm/W	4000K	596x596x15	2,0 kg

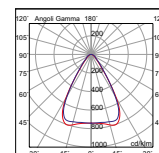

versione DALI e SENSORE AMBIENTALE per tutti i codici
DALI and ENVIRONMENTAL SENSOR version available for all codes

esempio/example cod.**OPT003DA - OPT003SM**

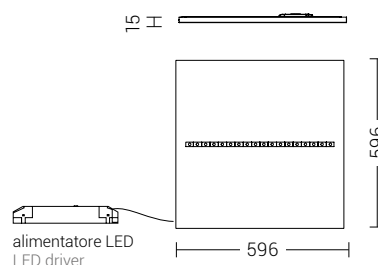

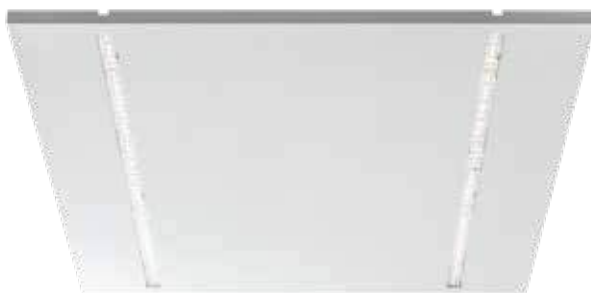

Finiture Finishing



B-bianco white

Codice Code	Potenza Power	Flusso effettivo Real flux	Efficienza Efficiency	CCT	Dimensioni mm Dimensions mm	Peso Weight
OPT005	26W	3686 lm	142 lm/W	3000K	596x596x15	2,0 kg
OPT006	26W	3800 lm	147 lm/W	4000K	596x596x15	2,0 kg

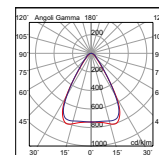

versione DALI e SENSORE AMBIENTALE per tutti i codici
DALI and ENVIRONMENTAL SENSOR version available for all codes

esempio/example cod.**OPT005DA - OPT005SM**

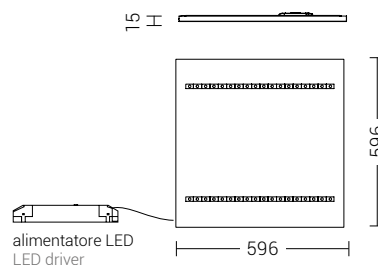

ACCESSORI ACCESSORIES

Telaio per installazione in cartongesso Frame for recessed installation

Profilo in alluminio verniciato bianco
White painted aluminium profile

L:635mm La:635mm H:85,5mm

foro: 620x620 mm

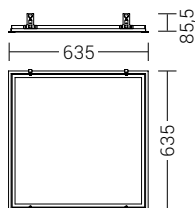

Cod.

OPT106MT

Cornice per attacco a plafone Frame for ceiling fitting

Profilo in alluminio verniciato bianco
White painted aluminium profile

L:603mm La:603mm H:48mm

foro: 609x609 mm

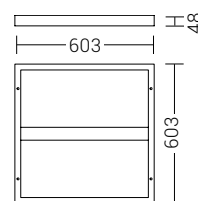

Cod.

OPT107MT



KINA *evo*

VARIETÀ DI STILE
VARIETY OF STYLE

Faretto LED ad incasso con struttura in pressofusione di alluminio e diffusore in policarbonato. Ideale per illuminare in modo uniforme gli ambienti di passaggio e le aree retail. E' disponibile in tre dimensioni con relative potenze ed è dotato di uno switch che permette di selezionare differenti temperature colore.

Round LED downlight with die-cast aluminium body and polycarbonate diffuser. It's ideal for lighting transit areas, corridors, common and retail areas. Available in three sizes with related powers and it's ideal for lighting transit areas, corridors, common and retail areas. Downlight equipped with switch to select the gradation.



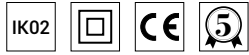

FINITURE FINISHES

Bianco. Verniciatura a polvere.
White. Powder coating.



Bianco White

SORGENTE SOURCE

Faretto LED dotato di switch per la scelta della temperatura colore (3000K-3500K-4000K), CRI>90 e una vita attesa eccezionale di 50.000 ore.

LED downlight with switch to select the gradations between (3000K-3500K-4000K) and CRI>90 and lifetime of 50.000 hours.

ELETTRIFICAZIONE POWER SUPPLY

220-240V. Gruppo di alimentazione incluso, da installare in remoto.

220-240V. Remote driver included..

EMISSIONE LUMINOSA LIGHT EMISSION

Monoemissione per emissione del flusso luminoso diretto.

LED luminaire for direct light emission.



CONTROLLO POWER SUPPLY

Disponibile nella versione dimmerabile con protocollo DALI.

Available in dimmable DALI version.

APPLICAZIONI ENVIRONMENTS

Ideale per illuminare in modo uniforme gli ambienti di passaggio, corridoi, aree comuni e spazi retail.

It's ideal for lighting transit areas, corridors, common and retail areas.

NORMATIVE REGULATIONS

EN 60598-1 (Apparecchi di illuminazione, prescrizioni generali)
EN 62471 (Rischio fotobiologico)
EN 12464-1 (Illuminazione dei luoghi di lavoro)
2014/35/UE (Direttiva bassa tensione)
2014/30/UE (Direttiva compatibilità elettromagnetica)

EN 60598-1 (Electric safety standards)
EN 62471 (Photobiological safety standards)
EN 12464-1 (Lighting of indoor workplaces)
2014/35/UE (Low Voltage Directive)
2014/30/UE (Electro-magnetic compatibility standards)

SU RICHIESTA UPON REQUEST

Kit di emergenza 3h da installare in remoto.

Remote emergency kit with 3 hours battery life.

INCASSO RECESSED



Finiture Finishing



bianco white



Codice Code	Potenza Power	Flusso effettivo Real flux	Efficienza Efficiency	CCT	Dimensioni mm Dimensions mm	Peso Weight
KIN101	8W	720-750-740 lm	90 lm/W	3000K - 3500K - 4000K	Ø 145x29	0,2 kg
KIN102	12W	1070-1100-1090 lm	92 lm/W	3000K - 3500K - 4000K	Ø 180x29	0,3 kg
KIN103	20W	1840-1900-1890 lm	93 lm/W	3000K - 3500K - 4000K	Ø 230x29	0,5 kg

versione DALI per tutti i codici
DALI version available for all codes

esempio/example cod. **KIN101DA**

per versione in emergenza ordinare a parte:
for emergency version to be ordered separately

cod. EM3H

Kit emergenza Emergency kit 3H
220-240V - 50/60HZ - 7,2V/1,6m Ah.

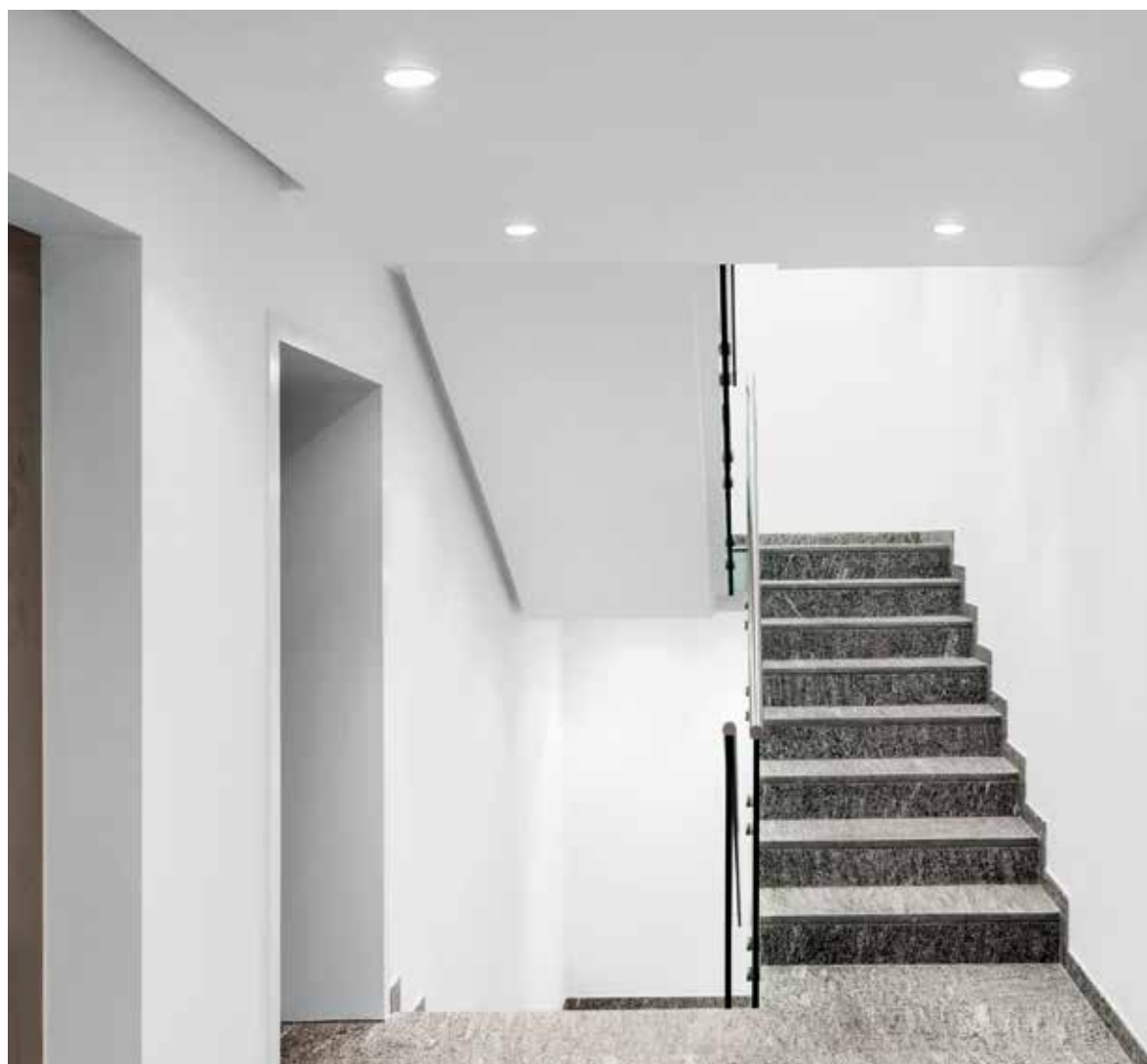
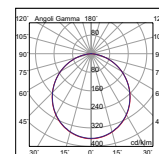
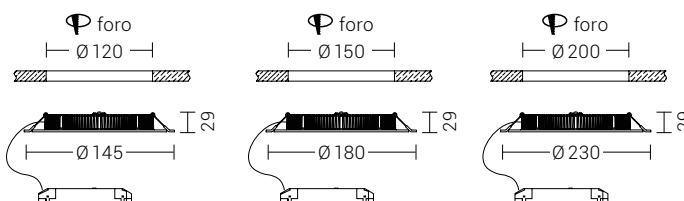



SMART

SCELTA RICERCATA ACCURATE CHOICE

Faretto LED ad incasso con struttura e parabola in alluminio e diffusore con vetro di protezione. Disponibile in quattro dimensioni con relative potenze, è una gamma perfetta per illuminare correttamente differenti spazi comuni e aree dedicate al retail

LED downlight, with aluminium body and parabola and transparent glass diffuser with protective glass. Available in four sized and related powers, it is a perfect range to properly illuminate common and retail areas.



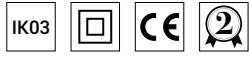

FINITURE FINISHES

Bianco. Verniciatura a polvere.
White. Powder coating.



Bianco White

SORGENTE SOURCE

Apparecchio LED dalle alte prestazioni, disponibile in due temperature colore (3000K e 4000K), CRI>90 e una vita attesa di 50.000 ore.

High performance LED modules, available in two gradations (3000K and 4000K) and CRI>90 and lifetime of 50.000 hours.

ELETTRIFICAZIONE POWER SUPPLY

220-240V. Gruppo di alimentazione incluso, da installare in remoto.

220-240V. Remote driver included.

EMISSIONE LUMINOSA LIGHT EMISSION

Monoemissione a luce diretta e UGR<19.

LED luminaire for direct light emission and UGR<19.



CONTROLLO POWER SUPPLY

Disponibile nella versione dimmerabile con protocollo DALI.

Available in dimmable DALI version.

APPLICAZIONI ENVIRONMENTS

Per installazione in ambienti con videotermini, aree comuni, corridoi, negozi e aree dedicate al retail.

For VDU workstations, common areas, corridors, for shops and retail areas.

NORMATIVE REGULATIONS

EN 60598-1 (Apparecchi di illuminazione, prescrizioni generali)
EN 62471 (Rischio fotobiologico)
EN 12464-1 (Illuminazione dei luoghi di lavoro)
2014/35/UE (Direttiva bassa tensione)
2014/30/UE (Direttiva compatibilità elettromagnetica)

EN 60598-1 (Electric safety standards)
EN 62471 (Photobiological safety standards)
EN 12464-1 (Lighting of indoor workplaces)
2014/35/UE (Low Voltage Directive)
2014/30/UE (Electro-magnetic compatibility standards)

SU RICHIESTA UPON REQUEST

Kit di emergenza 3h da installare in remoto.

Remote emergency kit with 3 hours battery life.

INCASSO RECESSED



Finiture Finishing



bianco white

Codice Code	Potenza Power	Flusso effettivo Real flux	Efficienza Efficiency	CCT	Dimensioni mm Dimensions mm	Peso Weight
SMA101	15W	1200 lm	80 lm/W	3000K	Ø136x75	0,3 kg
SMA102	15W	1260 lm	84 lm/W	4000K	Ø136x75	0,3 kg
SMA103	22W	1860 lm	85 lm/W	3000K	Ø175x100	0,6 kg
SMA104	22W	1900 lm	87 lm/W	4000K	Ø175x100	0,6 kg
SMA105	30W	2630 lm	88 lm/W	3000K	Ø196x105	0,9 kg
SMA106	30W	2750 lm	92 lm/W	4000K	Ø196x105	0,9 kg
SMA107	36W	3330 lm	93 lm/W	3000K	Ø230x125	1,2 kg
SMA108	36W	3820 lm	107 lm/W	4000K	Ø230x125	1,2 kg

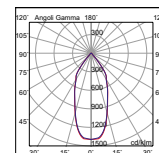

versione DALI per tutti i codici
DALI version available for all codes

esempio/example cod. **SMA001DA**

per versione in emergenza ordinare a parte:
for emergency version to be ordered separately

cod. EM3H

Kit emergenza Emergency kit 3H
220-240V - 50/60HZ - 7,2V/1,6m Ah.

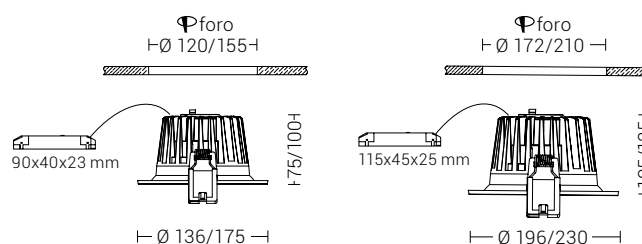

POINT

ESSENZIALE ED
AFFIDABILE
ESSENTIAL AND
RELIABLE

Apparecchio LED installabile a parete o a plafone. Grazie al suo design semplice e compatto si presta per ogni soluzione progettuale. Per la sua alta durata nel tempo, è un prodotto adatto soprattutto nelle aree comuni di ambienti pubblici e privati, alle zone di passaggio, corridoi o scale. È ideale anche in ambienti esterni soggetti a polvere e umidità, in virtù del grado di protezione IP44.

Wall and ceiling LED lamp. Thanks to its simple and compact design it is suitable for any design solution. Due to its high durability, it is a suitable especially in public and private areas, in transit areas, corridors or stairs. Thanks to the degree of protection IP44, it's also ideal in dust and wet outdoor environments.



Struttura dalla forma rotonda in lamiera d'acciaio verniciata con polvere epossidica e diffusore opale in PMMA per un effetto di luce diffusa.

Round sheet steel body painted with epoxy powder and opal PMMA diffuser for diffused light emission.





FINITURE FINISHES

Bianco. Verniciatura a polvere.
White. Powder coating.



Bianco White

SORGENTE SOURCE

Apparecchio LED dalle alte prestazioni, disponibile in due temperature colore (3000K e 4000K), CRI>90, e una vita attesa di 80.000 ore.

High performance LED modules, available in two gradations (3000K and 4000K), CRI>90 and lifetime of 80.000 hours.

ELETRIFICAZIONE POWER SUPPLY

220-240V. Gruppo di alimentazione integrato, montato a bordo dell'apparecchio.

220-240V. On board driver.

EMISSIONE LUMINOSA LIGHT EMISSION

Monoemissione a luce diretta.
LED luminaire for direct light emission.



CONTROLLO POWER SUPPLY

Disponibile nella versione dimmerabile con protocollo DALI, con sensore di presenza/crepuscolare ed emergenza.

Available in dimmable DALI, with motion/twilight sensor and emergency version.

APPLICAZIONI ENVIRONMENTS

Grazie al suo design compatto si presta ad essere installato in zone di passaggio, spazi ristretti, corridoi, scale e aree comuni. In virtù del grado di protezione IP44 è ideale anche in ambienti esterni soggetti a polvere e umidità.

Thanks to its compact design it can be installed in transit areas, small spaces, corridors, stairs and common areas. Thanks to the degree of protection IP44 it's also ideal in dust and wet outdoor environments.

NORMATIVE REGULATIONS

EN 60598-1 (Apparecchi di illuminazione, prescrizioni generali)
EN 62471 (Rischio fotobiologico)
EN 12464-1 (Illuminazione dei luoghi di lavoro)
2014/35/UE (Direttiva bassa tensione)
2014/30/UE (Direttiva compatibilità elettromagnetica)

EN 60598-1 (Electric safety standards)
EN 62471 (Photobiological safety standards)
EN 12464-1 (Lighting of indoor workplaces)
2014/35/UE (Low Voltage Directive)
2014/30/UE (Electro-magnetic compatibility standards).

SU RICHIESTA UPON REQUEST

Kit di emergenza 3h da installare in remoto.

Remote emergency kit with 3 hours battery life.

PARETE/PLAFONE WALL/CEILING



Finiture Finishing



bianco white

Codice Code	Potenza Power	Flusso effettivo Real flux	Efficienza Efficiency	CCT	Dimensioni mm Dimensions mm	Peso Weight
POI001	20W	1940 lm	97 lm/W	3000K	Ø285x89	1,0 kg
POI002	20W	2000 lm	100 lm/W	4000K	Ø285x89	1,0 kg
POI003	27W	2620 lm	98 lm/W	3000K	Ø375x108	1,6 kg
POI004	27W	2700 lm	100 lm/W	4000K	Ø375x108	1,6 kg

Versione con sensore di presenza/crepuscolare Twilight/motion sensor version  

POI001SM	20W	1940 lm	97 lm/W	3000K	Ø285x89	1,0 kg
POI002SM	20W	2000 lm	100 lm/W	4000K	Ø285x89	1,0 kg
POI003SM	27W	2620 lm	98 lm/W	3000K	Ø375x108	1,6 kg
POI004SM	27W	2700 lm	100 lm/W	4000K	Ø375x108	1,6 kg

Versione con sensore di presenza/crepuscolare + emergenza Twilight/motion sensor version + emergency   

POI003SMEM3	27W	2620 lm	98 lm/W	3000K	Ø375x108	1,6 kg
POI004SMEM3	27W	2700 lm	100 lm/W	4000K	Ø375x108	1,6 kg

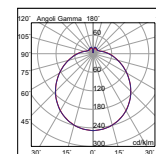

versione DALI, EMERGENZA e EMERGENZA DALI per tutti i codici
DALI, EMERGENCY and DALI EMERGENCY version available for all codes

esempio/example cod. **POI1101DA - POI1101SMDA - POI1101SMEM3DA**

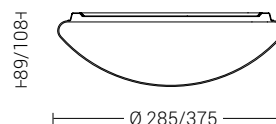

In presenza di persone, l'apparecchio si accende.

When people stay, the luminaire switches on.



In assenza di persone, l'apparecchio si spegne, dopo un intervallo temporale impostato dall'utente (in fase di installazione dell'accessorio).

When people are away, the luminaire switches off, after a set up time (value to set up during the installation of the device).





FIT

ELEVATA EFFICIENZA HIGH EFFICIENCY

Apparecchio LED specifico per illuminare ambienti molto ampi con soffitti elevati. Certificato per il ball-test, è la scelta ideale per ambienti dove si svolgono attività sportive indoor ma anche per aree industriali. Grazie all'adozione di gruppi ottici dalle alte performance, la sorgente offre un'eccellente efficienza permettendo un elevato risparmio energetico, oltre a garantire un flusso luminoso con basso valore di UGR.

LED luminaire specific for large rooms with high ceilings, gyms, sports halls and industrial areas. Ball-test certified, it is the ideal for indoor sports and industrial areas. Thanks to the high-performance lighting units, it offers excellent efficiency allowing high energy saving and a luminous flux with low UGR.



Struttura in alluminio e sistema di lenti ottiche in policarbonato ad alta luminosità per diffondere la luce in modo uniforme, dato il suo ambito di utilizzo. Installabile a plafone, parete o a sospensione, è la soluzione ideale per molteplici ambiti di progettazione.

Aluminium body and polycarbonate optical lenses with high brightness to spread the light evenly. Ceiling, wall or suspension installation, it is the ideal solution for many design areas.



FINITURE FINISHES

Bianco. Verniciatura a polvere.

White. Powder coating.



Bianco White

EMISSIONE LUMINOSA LIGHT EMISSION

Monoemissione per luce diretta e UGR<22.

LED luminaire for direct light emission and UGR<22.



NORMATIVE REGULATIONS

EN 60598-1 (Apparecchi di illuminazione, prescrizioni generali)
EN 62471 (Rischio fotobiologico)
EN 12464-1 (Illuminazione dei luoghi di lavoro)
2014/35/UE (Direttiva bassa tensione)
2014/30/UE (Direttiva compatibilità elettromagnetica)

EN 60598-1 (Electric safety standards)
EN 62471 (Photobiological safety standards)
EN 12464-1 (Lighting of indoor workplaces)
2014/35/UE (Low Voltage Directive)
2014/30/UE (Electro-magnetic compatibility standards).

SORGENTE SOURCE

Apparecchio LED dalle alte prestazioni, temperatura colore 4000K, CRI>80 e una vita attesa di 80.000 ore.

High performance LED modules, available in 4000K, CRI>90 and lifetime of 80.000 hours.

ELETTRIFICAZIONE POWER SUPPLY

220-240V. Gruppo di alimentazione integrato, montato a bordo dell'apparecchio.

220-240V. On board driver.

CONTROLLO POWER SUPPLY

Disponibile nella versione dimmerabile con protocollo DALI.

Available in dimmable DALI version.

APPLICAZIONI ENVIRONMENTS

Apparecchio illuminotecnico specifico per illuminare ambienti ampi, con soffitti elevati, come palestre, palazzetti sportivi e aree industriali.

Specific lighting fixture to illuminate large rooms with high ceilings, such as gyms, sports halls and industrial areas.

SU RICHIESTA UPON REQUEST

Versione con sensore ambientale vedi pag. 92

Enviro nmental sensor version see pag. 92

PARETE/PLAFONE/SOSPENSIONE WALL/CEILING/SUSPENSION

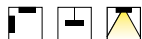

Finiture Finishing



bianco white



Codice Code	Potenza Power	Flusso effettivo Real flux	Efficienza Efficiency	CCT	Dimensioni mm Dimensions mm	Peso Weight
FIT001	45W	7500 lm	167 lm/W	4000K	585x213x42	3,5 kg
FIT002	85W	15800 lm	186 lm/W	4000K	1180x213x42	5,2 kg
FIT003	130W	24000 lm	185 lm/W	4000K	1650x213x42	7,2 kg

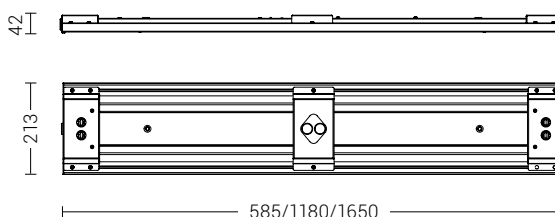
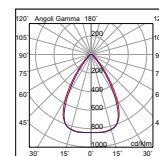

versione DALI per tutti i codici
DALI version available for all codes

esempio/example cod.**FIT001DA**



CABLAGGIO LATERALE SIDE WIRING



OTTICA OPTICS

ACCESSORI ACCESSORIES

Kit sospensione Suspension Kit

Kit per il fissaggio a sospensione con gancio ad anello e moschettone.

Ring hook with carabiner kit for suspension installation.



Cod.

FIT001MT (Kit sospensione per suspension Kit for FIT001)

FIT002MT (Kit sospensione per suspension Kit for FIT002 - FIT003)

Staffa orientabile Fixing bracket

Staffa in pressofusione di alluminio per installazione a parete e a plafone che permette l'orientabilità del corpo illuminante di 90°.

Die-cast aluminium bracket for wall and ceiling installation, which allows adjusting the luminaire of 90°.

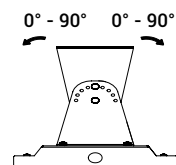

Cod.

FIT003MT

SENSORE AMBIENTALE

L'innovativo sensore adottato su questi corpi illuminanti permette di rilevare l'occupazione e il livello di luce naturale e, grazie all'uso della tecnologia BLE, impostare alcuni parametri tramite l'App MasterConnect (Philips). Queste caratteristiche rendono gli apparecchi particolarmente adatti ai requisiti CAM per l'uso in sale conferenze, uffici, aule, lobby, scale e aree comuni.

Rilevamento dell'occupazione Occupation detection

L'area di rilevamento del sensore di movimento può essere suddivisa approssimativamente in due parti.

The motion sensor detection area can be roughly divided into two parts.

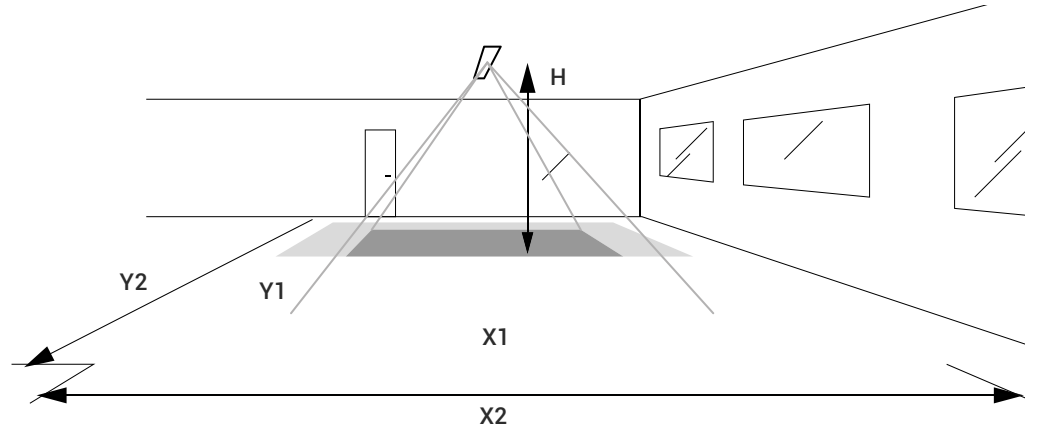

Altezza (m) Height (m)	Movimento minore persona in movimento $\leq 0,9$ m/s Minor movement moving person $\leq 0,9$ m/s		Movimento maggiore: persona in movimento $\geq 0,9$ m/s Greater movement moving person $\geq 0,9$ m/s	
H (m)	X1 (m)	Y1 (m)	X2 (m)	Y2 (m)
2.4	1.9	2.9	2.9	4.3
3	2.4	3.6	3.6	5.4

Parametri configurabili tramite App Parameters configurable by App

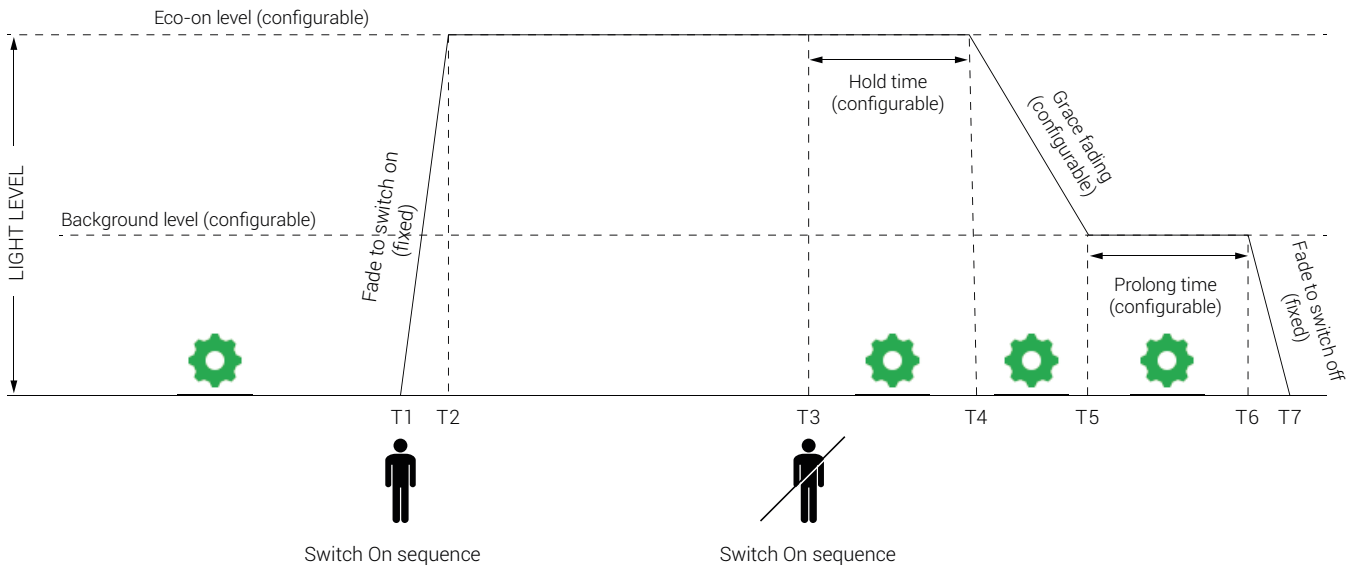

ENVIRONMENTAL SENSOR

The innovative sensor adopted on these luminaires allows you to detect the occupation and level of natural light and set some parameters via the MasterConnect App (Philips), thanks to the use of BLE technology. These features make the luminaires particularly suitable for MEC requirements for use in conference rooms, offices, classrooms, lobbies, staircases and common areas.

Rilevamento luce naturale Natural Light detection

Il sensore di luce misura la quantità totale di luce, coprendo circa l'80% dell'area di rilevamento PIR.

Consigli per una corretta installazione: distanza minima dalla finestra $\geq 0,6$ m; evitare riflessi di luce direttamente nel sensore; per calcolare la distanza minima tra la finestra e il sensore si può utilizzare la formula $0,72 \times h$, dove h è l'altezza di posizionamento del sensore.



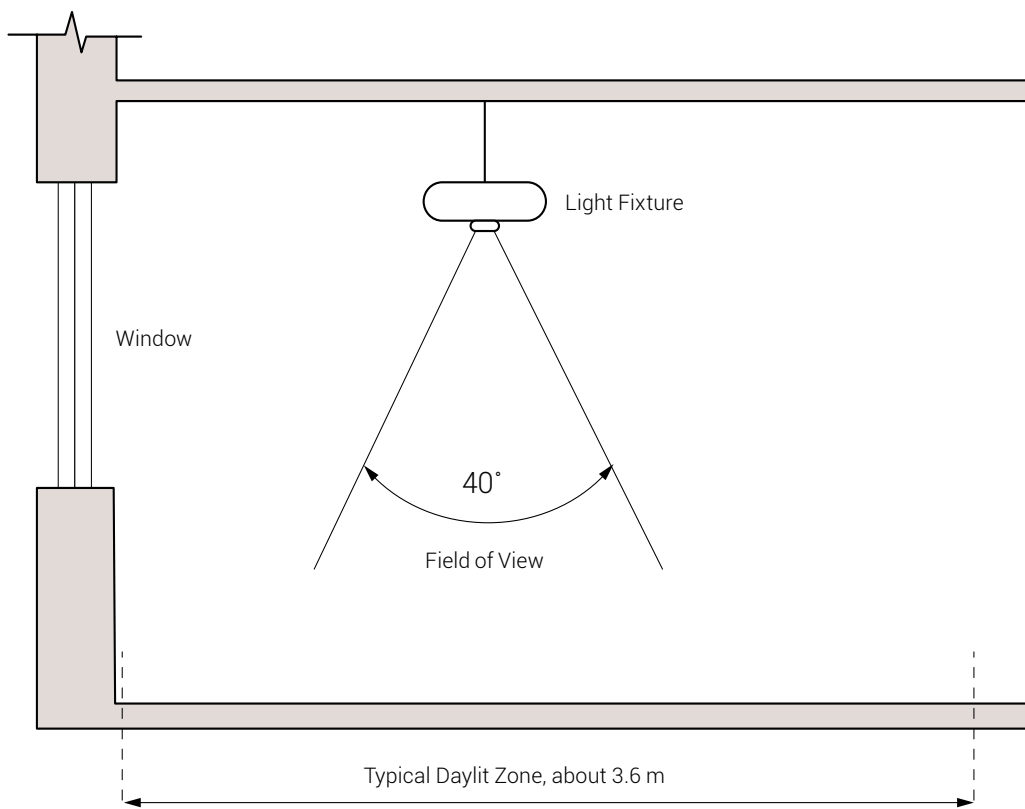

The light sensor measures the total amount of light, covering about 80% of the PIR detection area.

Tips for proper installation: minimum distance from the window 0.6 m; avoid light reflections directly in the sensor; to calculate the minimum distance between the window and the sensor you can use the formula $0.72 \times h$, where h is the positioning height of the sensor.



LEGENDA LEGEND

SIMBOLOGIE E CARATTERISTICHE SYMBOLS AND FEATURES

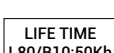
-  MONOEMISSIONE
DIRECT LIGHT
-  BIEMISSIONE
DIRECT/INDIRECT LIGHT
-  SENSORE DI PRESENZA
MOTION SENSOR
-  SENSORE CREPUSCOLARE
TWILIGHT SENSOR
-  **UGR**
≤19 PRODOTTO CON UGR <19
UGR <19 FITTING
-  **UGR**
≤22 PRODOTTO CON UGR <22
UGR <22 FITTING
-  **CRI**
>80 INDICE DI RESA CROMATICA
COLOR RENDERING INDEX
-  **CRI**
>90 INDICE DI RESA CROMATICA
COLOR RENDERING INDEX
-  **RGO** RISCHIO FOTOBIOLOGICO (ESENTE)
PHOTOBIOLOGICAL RISK (EXEMPT RISK)
-  **4000K** TEMPERATURA COLORE DISPONIBILE 4000K
GRADATION AVAILABLE 4000K
-  **3000K**
4000K TEMPERATURA COLORE DISPONIBILI (3000K E 4000K)
GRADATION AVAILABLE (3000K AND 4000K)
-  **3000K**
3500K
4000K TEMPERATURA COLORE SELEZIONABILE (3000K, 3500K E 4000K)
GRADATION SELECTABLE (3000K, 3500K AND 4000K)
-  CERTIFICATO BALL-TEST
BALL-TEST CERTIFIED
-  **1h** KIT D'EMERGENZA - DURATA BATTERIA 1 ORA
EMERGENCY KIT - 1 HOUR BATTERY LIFE
-  **3h** KIT D'EMERGENZA - DURATA BATTERIA 3 ORE
EMERGENCY KIT - 3 HOURS BATTERY LIFE
-  **2** GARANZIA PRODOTTO 2 ANNI
2 YEAR PRODUCT WARRANTY
-  **5** GARANZIA PRODOTTO 5 ANNI
5 YEAR PRODUCT WARRANTY
-  **40°** OTTICA 40°
40° OPTICS
-  **60°** OTTICA 60°
60° OPTICS
-  **110°** OTTICA 110°
110° OPTICS
-  **LIFE TIME**
L70/B50:30Kh DURATA VITA 30.000 ORE
30.000 HOURS LIFE TIME
-  **LIFE TIME**
L80/B10:50Kh DURATA VITA 50.000 ORE
50.000 HOURS LIFE TIME
-  **LIFE TIME**
L80/B50:80Kh DURATA VITA 80.000 ORE
80.000 HOURS LIFE TIME

TIPOLOGIA TYPOLOGY



SOSPENSIONE
SUSPENSION



APPARECCHIO A PARETE/PLAFONE
WALL/CEILING LUMINAIRE



APPARECCHIO A PLAFONE
CEILING LUMINAIRE



INCASSO A SOFFITTO
DOWNLIGHTS



SISTEMI
SYSTEM LUMINAIRES

CLASSI DI ISOLAMENTO INSULATION CLASSES



APPARECCHIO DI CLASSE I CON MORSETTO A TERRA
CLASS I PRODUCT WITH EARTH TERMINAL



APPARECCHIO DI CLASSE II
CLASS II PRODUCT



CERTIFICAZIONE CONFORMITÀ EUROPEA
EUROPEAN CONFORMITY CERTIFICATION

GRADO DI RESISTENZA AGLI URTI - IK IMPACT RESISTANCE - IK



PROTETTO CONTRO L'ENERGIA D'URTO DI 0,20 JOULE
PROTECTED AGAINST 0,20 JOULE IMPACT ENERGY



PROTETTO CONTRO L'ENERGIA D'URTO DI 0,35 JOULE
PROTECTED AGAINST 0,35 JOULE IMPACT ENERGY



PROTETTO CONTRO L'ENERGIA D'URTO DI 1 JOULE
PROTECTED AGAINST 1 JOULE IMPACT ENERGY

SIMBOLI DIMERAZIONE DIMMING SYMBOL



PUSH DIMMER
DIMMER PUSH



SISTEMA STANDARD INTERFACCIA DIGITALE
DIGITAL ADDRESSABLE LIGHTING INTERFACE



SISTEMA STANDARD INTERFACCIA DIGITALE - DALI2
DIGITAL ADDRESSABLE LIGHTING INTERFACE - DALI2



CRITERI AMBIENTALI MINIMI
MINIMUM ENVIRONMENTAL CRITERIA

GRADO DI PROTEZIONE - IP INTERNATIONAL PROTECTION - IP



PROTETTO CONTRO LA PENETRAZIONE DI CORPI SOLIDI CON DIAMETRO SUPERIORE DI 12 MM E NON CONTRO I LIQUIDI
PROTECTED AGAINST THE PENETRATION OF SOLID MATTER WITH DIAMETERS OVER 12 MM BUT NOT AGAINST LIQUIDS



PROTETTO CONTRO LA PENETRAZIONE DI CORPI SOLIDI CON DIAMETRO SUPERIORE DI 1 MM E NON CONTRO I LIQUIDI
PROTECTED AGAINST THE PENETRATION OF SOLID MATTER WITH DIAMETERS OVER 1 MM BUT NOT AGAINST LIQUIDS



PROTETTO CONTRO LA PENETRAZIONE DI CORPI SOLIDI CON DIAMETRO SUPERIORE DI 1 MM E GLI SPRUZZI D'ACQUA DA TUTTE LE DIREZIONI
PROTECTED AGAINST THE PENETRATION OF SOLID MATTER WITH DIAMETERS OVER 1 MM AND SPLASH-PROOF FROM ANY DIRECTION



IP20 LATO INCASSO - IP40 LATO ESTERNO
IP20 RECESSED SIDE - IP 40 OUTSIDE



scopri tutta la nostra collezione
discover our entire collection

**COPYRIGHT by ROSSINI
ILLUMINAZIONE s.r.l.
È VIETATA LA RIPRODUZIONE
ANCHE PARZIALE DEL CATALOGO**

Nella continua ricerca di miglioramenti tecnici e funzionali, ROSSINI ILLUMINAZIONE si riserva il diritto di apportare modifiche anche sostanziali ai propri prodotti, che potranno essere effettuate senza preavviso. Disegni, quote e colori sono da intendersi a titolo puramente indicativo e non sono impegnative per ROSSINI ILLUMINAZIONE.

ROSSINI ILLUMINAZIONE è presente su tutto il territorio italiano attraverso un'ampia rete di rivenditori. Per scoprire il negozio più vicino a te contatta uno dei nostri agenti (elenco consultabile sul sito www.rossinigroup.it).

Per vedere dal vivo tutte le novità ROSSINI vieni a trovarci presso il nostro show-room a Segrate.

**COPYRIGHT by ROSSINI
ILLUMINAZIONE s.r.l.
THE REPRODUCTION OF THE
CATALOGUE EVEN PARTIAL IS
FORBIDDEN**

In the continuous search for technical and functional improvements, ROSSINI ILLUMINAZIONE reserves the right to make even substantial changes to its products, which may be made without notice. Drawings, dimensions and colors are for illustration only and are not binding for ROSSINI ILLUMINAZIONE.

ROSSINI ILLUMINAZIONE is present throughout the Italian territory through a wide network of dealers. To find the nearest store, please contact our agents (see list on www.rossinigroup.it).

To see live all new products of ROSSINI come and visit us at our showroom in Segrate.

ROSSINI ILLUMINAZION SRL
Via Kennedy, 5
20054 Segrate (MI) - ITALY
T. +39 02 2169501

inforossinigroup.it
www.rossinigroup.it

P. IVA IT08017160154

